

JVC

SERVICE MANUAL

AUDIO VIDEO CONTROL RECEIVER

RX-630RBK

Area Suffix

- B U.K.
- E Continental Europe
- EN North Europe
- G Germany

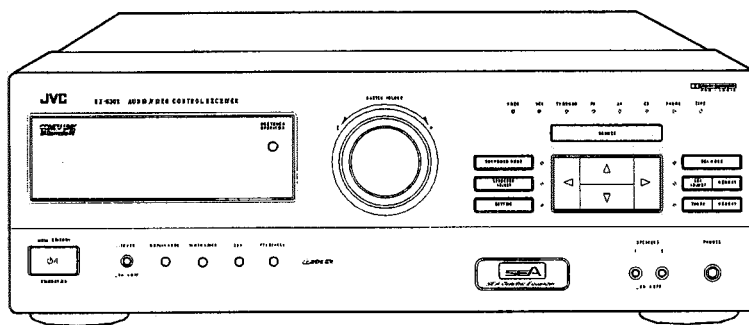
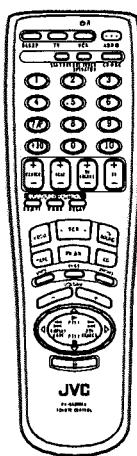

Contents

Safety Precautions	1-2,3	Adjustment Procedures	2-18
Instruction Book	1-4~31	Block Diagrams	2-20
Description of Major ICs	2-1	Schematic Diagrams	2-21
Internal Connection of Display	2-9	Printed Circuit Boards	2-27-30
Main Layout	2-10	Parts List	3-1~3-17
Disassembly Procedures	2-13		

Safety Precautions

1. This design of this product contains special hardware and many circuits and components specially for safety purposes. For continued protection, no changes should be made to the original design unless authorized in writing by the manufacturer. Replacement parts must be identical to those used in the original circuits. Services should be performed by qualified personnel only.
2. Alterations of the design or circuitry of the product should not be made. Any design alterations of the product should not be made. Any design alterations or additions will void the manufacturer's warranty and will further relieve the manufacture of responsibility for personal injury or property damage resulting therefrom.
3. Many electrical and mechanical parts in the products have special safety-related characteristics. These characteristics are often not evident from visual inspection nor can the protection afforded by them necessarily be obtained by using replacement components rated for higher voltage, wattage, etc. Replacement parts which have these special safety characteristics are identified in the Parts List of Service Manual. Electrical components having such features are identified by shading on the schematics and by (\triangle) on the Parts List in the Service Manual. The use of a substitute replacement which does not have the same safety characteristics as the recommended replacement parts shown in the Parts List of Service Manual may create shock, fire, or other hazards.
4. The leads in the products are routed and dressed with ties, clamps, tubings, barriers and the like to be separated from live parts, high temperature parts, moving parts and/or sharp edges for the prevention of electric shock and fire hazard. When service is required, the original lead routing and dress should be observed, and it should be confirmed that they have been returned to normal, after re-assembling.
5. Leakage current check (Electrical shock hazard testing)
After re-assembling the product, always perform an isolation check on the exposed metal parts of the product (antenna terminals, knobs, metal cabinet, screw heads, headphone jack, control shafts, etc.) to be sure the product is safe to operate without danger of electrical shock. Do not use a line isolation transformer during this check.

- Plug the AC line cord directly into the AC outlet. Using a "Leakage Current Tester", measure the leakage current from each exposed metal parts of the cabinet, particularly any exposed metal part having a return path to the chassis, to a known good earth ground. Any leakage current must not exceed 0.5mA AC (r.m.s.)

- Alternate check method
Plug the AC line cord directly into the AC outlet. Use an AC voltmeter having, 1,000 ohms per volt or more sensitivity in the following manner. Connect a 1,500 Ω 10W resistor paralleled by a 0.15 μ F AC-type capacitor between an exposed metal part and a known good earth ground.

Measure the AC voltage across the resistor with the AC voltmeter.

Move the resistor connection to each exposed metal part, particularly any exposed metal part having a return path to the chassis, and measure the AC voltage across the resistor. Now, reverse the plug in the AC outlet and repeat each measurement. voltage measured Any must not exceed 0.75 V AC (r.m.s.). This corresponds to 0.5 mA AC (r.m.s.).

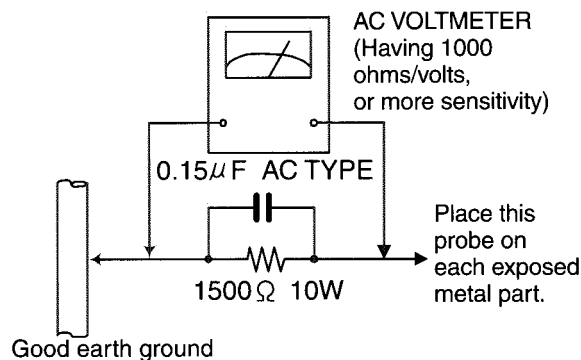

Warning

1. This equipment has been designed and manufactured to meet international safety standards.
2. It is the legal responsibility of the repairer to ensure that these safety standards are maintained.
3. Repairs must be made in accordance with the relevant safety standards.
4. It is essential that safety critical components are replaced by approved parts.
5. If mains voltage selector is provided, check setting for local voltage.

Safety Precautions (U.K only)

1. This design of this product contains special hardware and many circuits and components specially for safety purposes. For continued protection, no changes should be made to the original design unless authorized in writing by the manufacturer. Replacement parts must be identical to those used in the original circuits.
2. Any unauthorised design alterations or additions will void the manufacturer's guarantee ; furthermore the manufacturer cannot accept responsibility for personal injury or property damage resulting therefrom.
3. Essential safety critical components are identified by (⚠) on the Parts List and by shading on the schematics, and must never be replaced by parts other than those listed in the manual. please note however that many electrical and mechanical parts in the product have special safety related characteristics. These characteristics are often not evident from visual inspection. Parts other than specified by the manufacturer may not have the same safety characteristics as the recommended replacement parts shown in the Parts List of the Service Manual and may create shock, fire, or other hazards.
4. The leads in the products are routed and dressed with ties, clamps, tubings, barriers and the like to be separated from live parts, high temperature parts, moving parts and/or sharp edges for the prevention of electric shock and fire hazard. When service is required, the original lead routing and dress should be observed, and it should be confirmed that they have been returned to normal, after re-assembling.

Warning

1. Service should be performed by qualified personnel only.
2. This equipment has been designed and manufactured to meet international safety standards.
3. It is the legal responsibility of the repairer to ensure that these safety standards are maintained.
4. Repairs must be made in accordance with the relevant safety standards.
5. It is essential that safety critical components are replaced by approved parts.
6. If mains voltage selector is provided, check setting for local voltage.

⚠ CAUTION Burrs formed during molding may be left over on some parts of the chassis. Therefore, pat attention to such burrs in the case of preforming repair of this system.

Instruction Book

English

Deutsch

Français

Nederlands

Español

Italiano

Warnings, Cautions and Others/Warnung, Achtung und sonstige Hinweise/ Mises en garde, précautions et indications diverses/Waarschuwingen, voorzorgen en andere mededelingen/Avisos, precauciones y otras notas/ Avvertenze e precauzioni da osservare

IMPORTANT for the U.K.
DO NOT cut off the mains plug from this equipment. If the plug is pulled out of the power points in your home or the cable is too short to reach a power point, then obtain an appropriate safety approved extension lead or consult your dealer.
BE SURE to replace the fuse only with an identical approved type, as originally fitted.
 If nonetheless the mains plug is cut off ensure to remove the fuse and dispose of the plug immediately, to avoid a possible shock hazard by inadvertent connection to the mains supply.
 If this product is not supplied fitted with a mains plug then follow the instructions given below.
IMPORTANT:
DO NOT make any connection to the terminal which is marked with the letter E or by the safety earth symbol or coloured green or green-and-yellow.
 The wires in the mains lead on this product are coloured in accordance with the following code:
 Blue : Neutral
 Brown : Live
 As these colours may not correspond with the coloured markings identifying the terminals in your plug proceed as follows:
 The wire which is coloured blue must be connected to the terminal which is marked with the letter N or coloured black.
 The wire which is coloured brown must be connected to the terminal which is marked with the letter L or coloured red.
IF IN DOUBT - CONSULT A COMPETENT ELECTRICIAN.

Per l'Italia:
 "Si dichiara che il questo prodotto di marca JVC è conforme alle prescrizioni del Decreto Ministeriale n.548 del 28/06/95 pubblicato sulla Gazzetta Ufficiale della Repubblica Italiana n.301 del 28/12/95."

VOORZICHTIG
 Ter vermindering van gevaar voor brand, elektrische schokken, enz.:
 1. Verwijder geen schroeven, covers of cabinet.
 2. Stel dit toestel niet bloot aan regen of vocht.

PRECAUCIÓN
 Para reducir riesgos de choques eléctricos, incendio, etc.:
 1. No extraiga los tornillos, los cubiertas ni la caja.
 2. No exponga este aparato a la lluvia o a la humedad.

ATTENZIONE
 Per ridurre il rischio di scosse elettriche, incendi, ecc...
 1. Non togliere viti, coperchi o la scatola.
 2. Non esporre l'apparecchio alla pioggia e all'umidità.

CAUTION
 To reduce the risk of electrical shocks, fire, etc.:
 1. Do not remove screws, covers or cabinet.
 2. Do not expose this appliance to rain or moisture.

ACHTUNG
 Zur Verhinderung von elektrischen Schlägen, Brandgefahr, usw.
 1. Keine Schrauben lösen oder Abdeckungen entfernen und nicht das Gehäuse öffnen.
 2. Dieses Gerät weder Regen noch Feuchtigkeit aussetzen.

ATTENTION
 Afin d'éviter tout risque d'électrocution, d'incendie, etc.:
 1. Ne pas enlever les vis ni les parmaux et ne pas ouvrir le coffret de l'appareil.
 2. Ne pas exposer l'appareil à la pluie ni à l'humidité.

Caution — Ⓞ POWER switch and STANDBY/ON Ⓞ/Ⓞ button!
 This apparatus is provided with a Ⓞ POWER switch to be able to minimize power consumption for safe use. Therefore,
 1. When doing initial setting, complete all the connections required, connect the mains plug into the wall outlet, and set the Ⓞ POWER switch to ON. After these, it will be available to operate STANDBY/ON Ⓞ/Ⓞ button and so on.
 2. When not in use, set the Ⓞ POWER switch to OFF.
 3. Disconnect the mains plug to shut the power off completely. The Ⓞ POWER switch and STANDBY/ON Ⓞ/Ⓞ button in any position do not disconnect the mains line.
 4. The power can be remote controlled.

Achtung — Ⓞ POWER-Schalter und STANDBY/ON Ⓞ/Ⓞ-Taste!
 Dieses Gerät hat einen Netzschalter. (Ⓞ POWER), um den Stromverbrauch für sichere Verwendung auf ein Minimum bringen zu können. Verfahren Sie deshalb wie folgt:
 1. Beim ursprünglichen Aufbau alle erforderlichen Anschlüsse herstellen, den Netzstecker in eine Wandsteckdose stecken, und den Ⓞ POWER-Schalter einschalten. Anschließend ist Betrieb der STANDBY/ON Ⓞ/Ⓞ-Taste usw. möglich.
 2. Wenn das Gerät nicht verwendet wird, den Ⓞ POWER-Schalter ausschalten.
 3. Den Netzstecker aus der Steckdose ziehen, um die Stromversorgung vollkommen zu unterbrechen. Der Ⓞ POWER-Schalter und die STANDBY/ON Ⓞ/Ⓞ-Taste unterbrechen in keiner Stellung die Stromversorgung vollkommen.
 4. Die Stromversorgung kann mit der Fernbedienung ein- und ausgeschaltet werden.

Attention — Commutateur Ⓞ POWER et d'une touche STANDBY/ON Ⓞ/Ⓞ!
 Cet appareil est équipé d'un commutateur Ⓞ POWER qui lui permet de réduire sa consommation d'électricité pour une utilisation plus sûre. Par conséquent,
 1. En procédant au réglage initial, compléter toutes les connexions nécessaires, connecter la fiche secteur dans la prise murale et mettre le commutateur Ⓞ POWER sur la position ON. Ensuite, il sera possible de contrôler la touche STANDBY/ON Ⓞ/Ⓞ, etc.
 2. Mettre le commutateur Ⓞ POWER sur la position OFF lorsque l'appareil n'est pas utilisé.
 3. Déconnecter la fiche secteur pour couper complètement le courant. Le commutateur Ⓞ POWER et la touche STANDBY/ON Ⓞ/Ⓞ ne coupent jamais complètement l'alimentation, quelle que soit leurs positions.
 4. L'alimentation peut être télécommandée.

Voorzichtig — Ⓞ POWER en STANDBY/ON Ⓞ/Ⓞ schakelaars!
 Dit apparaat is voorzien van een Ⓞ POWER hoofdschakelaar om het apparaat gebruiksvaarder te zetten, maar te zorgen dat het stroomverbruik minimaal blijft. Neem in verband hiermee het volgende in acht:
 1. Bij de eerste ingebruikneming zorg u eerst dat alle aansluitingen in orde zijn, dan steekt u de stekker in het stopcontact en dan zet u de Ⓞ POWER schakelaar in de "ON" stand. Daarna kunt u het apparaat aan- en uitschakelen met de STANDBY/ON Ⓞ/Ⓞ schakelaar.
 2. Wanneer u het apparaat geruime tijd niet gebruikt, kunt u beter de Ⓞ POWER schakelaar in de "OFF" stand zetten.
 3. Om de stroomconsumptie te verminderen, trekt u de stekker uit het stopcontact. Anders zal er altijd een geringe hoeveelheid stroom naar het apparaat lopen, ongeacht de stand van de STANDBY/ON Ⓞ/Ⓞ en de Ⓞ POWER.
 4. U kunt het apparaat ook met de afstandsbediening aan- en uitschakelen.

Precaución — Interruptor Ⓞ POWER y botón STANDBY/ON Ⓞ/Ⓞ!
 Esta unidad dispone de un interruptor Ⓞ POWER que sirve para reducir al mínimo el consumo de alimentación para proporcionar mayor seguridad operacional. Por lo tanto,
 1. Al efectuar el ajuste inicial, después de completar todas las conexiones requeridas, conectar el cable de alimentación a una toma de pared, y activar el interruptor Ⓞ POWER. Entonces, será posible ejecutar operaciones tales como la conmutación del estado de alimentación.
 2. Desactivar el interruptor Ⓞ POWER al dejar la unidad fuera de uso.
 3. Desconectar el cable de alimentación para desactivar la alimentación totalmente. Cualquiera que sea la posición de ajustes del interruptor Ⓞ POWER y el botón STANDBY/ON Ⓞ/Ⓞ, la alimentación no se corta completamente.
 4. La alimentación puede ser controlada remotamente.

Attenzione — Interruttore Ⓞ POWER e tasto STANDBY/ON Ⓞ/Ⓞ!
 Per ridurre al minimo l'assorbimento di corrente al fine della sicurezza, questo apparecchio è stato dotato di un interruttore Ⓞ POWER. Di conseguenza,
 1. Al momento dell'impostazione iniziale, completare tutti i collegamenti richiesti, inserire la spina del cavo di alimentazione nella presa a muro della rete elettrica e impostare l'interruttore Ⓞ POWER in posizione ON. Fatto ciò, sarà pronto all'uso STANDBY/ON Ⓞ/Ⓞ.
 2. Quando non in uso, impostare l'interruttore Ⓞ POWER in posizione OFF.
 3. Disinserire la spina del cavo di alimentazione dalla presa della rete elettrica per staccare completamente l'alimentazione. L'interruttore Ⓞ POWER e il tasto STANDBY/ON Ⓞ/Ⓞ in nessuna posizione staccano la linea di alimentazione elettrica principale.
 4. È possibile il controllo remoto dell'alimentazione.

Caution: Proper Ventilation
 To avoid risk of electric shock and fire and to protect from damage. Locate the apparatus as follows:
 Front: No obstructions open spacing
 Sides: No obstructions in 10 cm from the sides.
 Top: No obstructions in 10 cm from the top.
 Back: No obstructions in 15 cm from the back.
 Bottom: No obstructions, place on the level surface.
 In addition, maintain the best possible air circulation as illustrated.

Achtung: Angemessene Ventilation
 Stellen Sie das Gerät zur Verhütung von elektrischem Schlag und Feuer und zum Schutz gegen Beschädigung wie folgt auf:
 Vorderseite: Offener Platz ohne Hindernisse.
 Seiten: Keine Hindernisse innerhalb 10 cm von den Seiten.
 Rückseite: Keine Hindernisse innerhalb 10 cm von der Rückseite.
 Oberseite: Keine Hindernisse innerhalb 10 cm von der Oberseite.
 Unterseite: Keine Hindernisse. Auf eine ebene Oberfläche stellen.
 Zusätzlich die bestmögliche Luftzirkulation wie gezeigt erhalten.

Attention: Ventilation Correcte
 Pour éviter les chocs électriques, l'incendie et tout autre dégât. Disposer l'appareil en tenant compte des impératifs suivants
 Avant: Rien ne doit gêner le dégagement
 Flancs: Laisser 10 cm de dégagement latéral
 Dessus: Laisser 10 cm de dégagement supérieur
 Arrière: Laisser 15 cm de dégagement arrière
 Dessous: Rien ne doit obstruer par dessous; poser l'appareil sur une surface plate.
 Veiller également à ce que l'air circule le mieux possible comme illustré.

Voorzichtig: Zorg Voor Goede Ventilatie
 Om gevaar voor brand of een elektrische schok te voorkomen, dient u bij opstelling van het apparaat op de volgende punten te letten:
 Voorkant: Voldoende ruimte vrij houden.
 Zijkanten: Minstens 10 cm aan weerszijden vrij houden.
 Bovenkant: Niets bovenop plaatsen; 10 cm speling geven.
 Achterkant: Minstens 15 cm ruimte achteraan vrij houden.
 Onderkant: Opstellen op een egaal horizontaal oppervlak.
 Bovendien moet er rondom voldoende luchtdoorstroming zijn, zoals in de afbeelding aangegeven.

Precaución: Ventilación Adecuada
 Para evitar el riesgo de choque eléctrico e incendio y para proteger el aparato contra daños.
 Ubique el aparato de la siguiente manera:
 Frente: Espacio abierto sin obstrucciones
 Lados: 10 cm sin obstrucciones a los lados
 Parte superior: 10 cm sin obstrucciones en la parte superior
 Parte trasera: 15 cm sin obstrucciones en la parte trasera
 Fondo: Sin obstrucciones; coloque sobre una superficie nivelada
 Además, mantenga la mejor circulación de aire posible como se ilustra.

Attenzione: Problemi di Ventilazione
 Per evitare il rischio di folgorazioni ed incendi e proteggere l'unità da danni, installarla nel modo seguente.
 Davanti: Nessun ostacolo, spazio libero
 Lati: Nessun ostacolo per almeno 10 cm
 Sopra: Nessun ostacolo per almeno 10 cm
 Retro: Nessun ostacolo per almeno 15 cm
 Fondo: Libero ed in piano.
 Inoltre, mantenere il più possibile la circolazione dell'aria.

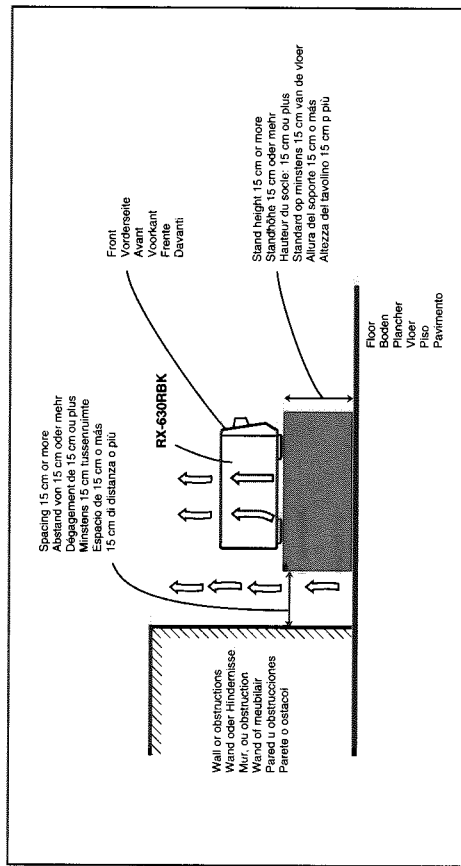

Getting Started

This section explains how to connect audio/video components and speakers to the receiver, and how to connect the power supply.

Before Installation

General

- Be sure your hands are dry.
- Turn the power off to all components.
- Read the manuals supplied with the components you are going to connect.

Locations

- Install the receiver in a location that is level and protected from moisture.
- The temperature around the receiver must be between -5° and 35° C (23° and 95° F).
- Make sure there is good ventilation around the receiver. Poor ventilation could cause overheating and damage the receiver.

Handling the receiver

- Do not insert any metal object into the receiver.
- Do not disassemble the receiver or remove screws, covers, or cabinet.
- Do not expose the receiver to rain or moisture.

Checking the Supplied Accessories

Check to be sure you have all of the following items, which are supplied with the receiver. The number in the parenthesis indicates the quantity of the pieces supplied.

- Remote Control (1)
 - Batteries (2)
 - AM (MW/LW) Loop Antenna (1)
 - FM Antenna (1)
- If anything is missing, contact your dealer immediately.

Table of Contents

Getting Started 2

Before Installation 2

Checking the Supplied Accessories 2

Switches, Buttons and Controls 3

Connecting the FM and AM (MW/LW) Antennas 5

Connecting the Speakers 6

Connecting Audio/Video Components 9

Connecting the Power Cord 10

Putting Batteries in the Remote Control 11

Basic Operations 12

Turning the Power On and Off 12

Selecting the Source to Play 12

Adjusting the Volume 13

Selecting the Front Speakers 13

Muting the Sound 14

Recording a Source 14

Basic Settings 15

Adjusting the Front Speaker Output Balance 15

Listening at Low Volume (Loudness) 15

Using the Sleep Timer 16

Selecting the Center Speaker Size 17

One Touch Operation 18

About the One Touch Operation 18

Using the One Touch Operation 18

Receiving Radio Broadcasts 19

Tuning in Stations Manually 19

Using Preset Tuning 19

Selecting the FM Reception Mode 20

Assigning Names to Preset Stations 21

Using the RDS (Radio Data System) to Receive FM Stations 22

What Information Can RDS Signals Provide? 22

Searching for a Program by PTY Codes 23

Switching to a Broadcast Program of Your Choice Temporarily 25

Using the SEA Modes 26

Selecting Your Favorite SEA Mode 26

Creating Your Own SEA Mode 27

Using the Surround Processor 28

Using JVC's Hall Surround 28

Speaker Arrangements for Dolby Surround 30

Preparing for Dolby Surround 31

Using Dolby Surround 34

COMPULINK Remote Control System 35

Using the Remote Control for Operating JVC Audio/Video Components 36

Troubleshooting 38

Specifications 39

Remote Control

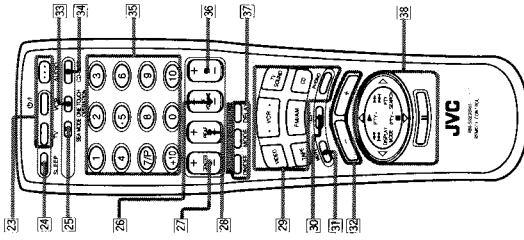

- Remote Control**
- 23 Power buttons (TV \odot / VCR \odot / AUDIO \odot /) (12, 37)
 - 24 SLEEP button (16)
 - 25 SEA MODE button (26)
 - 26 TV VOLUME buttons (+/-) (37)
 - 27 CENTER buttons (+/-) (33)
 - 28 REAR buttons (+/-) (29, 33)
 - 29 Source selecting buttons (13)
 - 30 TEST button (33)
 - 31 MUTE button (14)
 - 32 VOLUME buttons (+/-) (13)
 - 33 ONE TOUCH OPERATION button (18)
 - 34 CD-DISC button (36)
 - 35 10 keys (20, 36)
 - 36 CH (Channel) buttons (+/-) (37)
 - 37 SURROUND CONTROL buttons (ON/OFF, MODE, DELAY) (29, 33, 34)
 - 38 • Operating buttons for JVC audio/video components
 - RDS buttons (PTY SEARCH, DISPLAY MODE, PTY +, PTY -) (23, 24)

Switches, Buttons and Controls

Become familiar with the main switches and controls on your receiver before use.

Front Panel

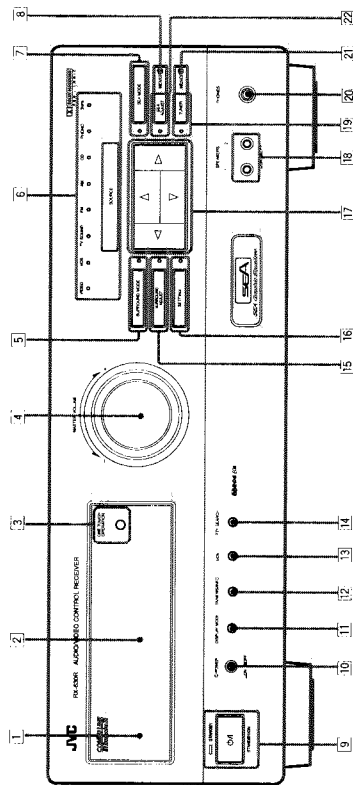

Refer to the pages in parentheses for details.

- Front Panel**
- 1 Remote sensor (11)
 - 2 Display (12)
 - 3 ONE TOUCH OPERATION button and lamp (18)
 - 4 MASTER VOLUME control (13)
 - 5 SURROUND MODE button and lamp (28, 31, 34)
 - 6 SOURCE button and lamps (12)
 - 7 SEA MODE button and lamp (26)
 - 8 MEMORY button for SEA adjustments (27)
 - 9 STANDBY/ON \odot / button and STANDBY lamp (12)
 - 10 POWER switch (10)
 - 11 DISPLAY MODE button (22)
 - 12 T.A/NEWS/INFO button (25)
 - 13 EON button (25)
 - 14 PTY SEARCH button (23)
 - 15 SURROUND ADJUST button and lamp (29, 31)
 - 16 SETTING button and lamp (15 to 17)
 - 17 Control Δ / ∇ / \leftarrow / \rightarrow buttons
 - 18 SPEAKERS 1/2 buttons (13)
 - 19 TUNER button and lamp (19)
 - 20 PHONES jack (14)
 - 21 MEMORY button for presetting channels (19)
 - 22 SEA ADJUST button and lamp (27)

IMPORTANT
 To use Control Δ / ∇ / \leftarrow / \rightarrow buttons (17) on the front panel:
 What these buttons actually do depends on which function you are trying to adjust. Before using these buttons, select the function by pressing one of the function selecting buttons (5, 6, 7, 15, 16, 18, 28), and being sure its lamp is lit.

Connecting the FM and AM (MW/LW) Antennas

FM Antenna Connections

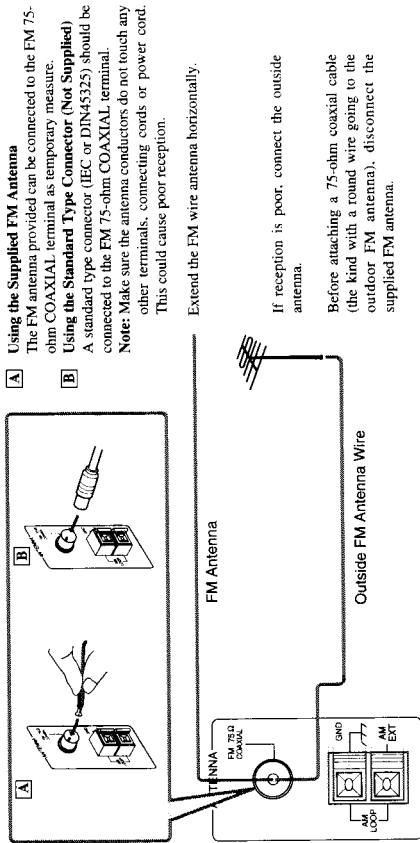

A Using the Supplied FM Antenna

The FM antenna provided can be connected to the FM 75-ohm COAXIAL terminal as temporary measure.

B Using the Standard Type Connector (Not Supplied)

A standard type connector (IEC or DIN45325) should be connected to the FM 75-ohm COAXIAL terminal.

Note: Make sure the antenna conductors do not touch any other terminals, connecting cords or power cord. This could cause poor reception.

Extend the FM wire antenna horizontally.

If reception is poor, connect the outside antenna.

Before attaching a 75-ohm coaxial cable (the kind with a round wire going to the outdoor FM antenna), disconnect the supplied FM antenna.

AM (MW/LW) Antenna Connections

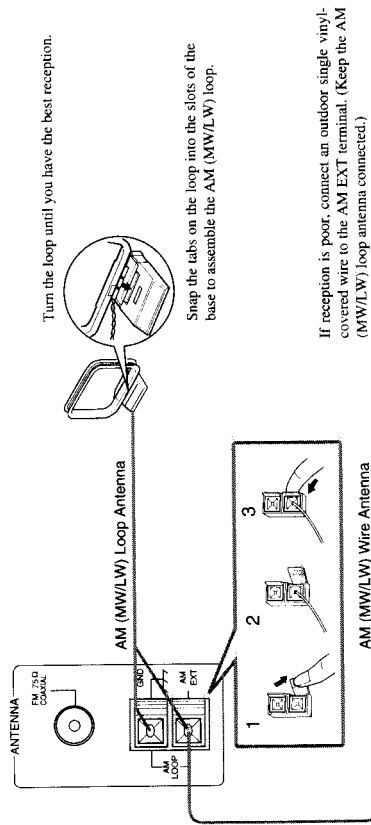

Turn the loop until you have the best reception.

Snap the tabs on the loop into the slots of the base to assemble the AM (MW/LW) loop.

If reception is poor, connect an outdoor single vinyl-covered wire to the AM EXT terminal. (Keep the AM (MW/LW) loop antenna connected.)

Note: Make sure the antenna conductors do not touch any other terminals, connecting cords and power cord. This could cause poor reception.

Connecting the Speakers

You can connect the following speakers:

- Two pairs of front speakers to produce normal stereo sound.
- One pair of rear speakers to enjoy the surround effect.
- One center speaker to produce more effective surround effect (to emphasize human voices).
- One subwoofer to enhance the bass.

For each speaker (except for subwoofer), connect the black (-) and red (+) terminals on the rear panel to the black (-) and red (+) terminals marked on the speakers. For connecting a subwoofer, see page 7.

CAUTION: Use speakers with the SPEAKER IMPEDANCE indicated by the speaker terminals.

Connecting the front speakers

Cut, twist and remove the insulation at the end of each speaker signal cable first, and then, connect the front speakers to the FRONT SPEAKERS terminals by using the cables. You can connect two pairs of front speakers (one pair to the FRONT SPEAKERS ① terminals, and another pair to the FRONT SPEAKERS ② terminals).

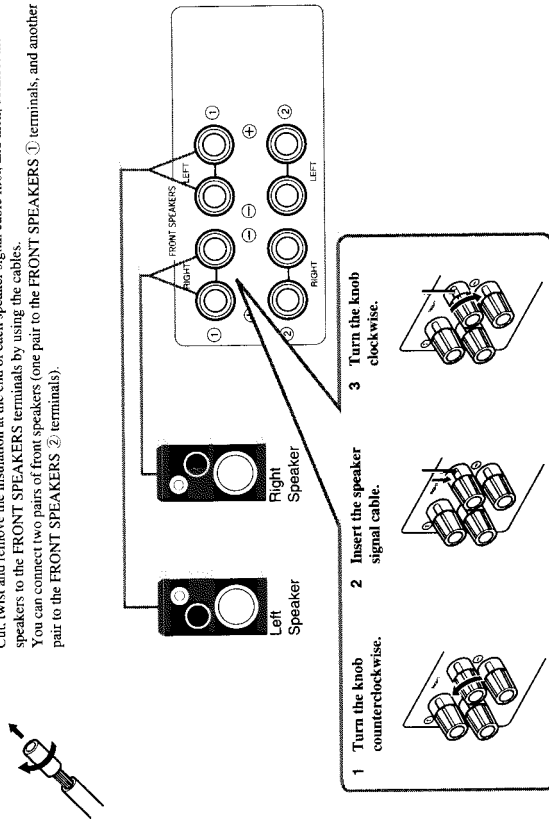

Connecting the rear and center speakers

Cut, twist and remove the insulation at the end of each speaker signal cable first, and then, connect rear speakers to the REAR SPEAKERS terminals and a center speaker to the CENTER SPEAKER terminals by using the cables.

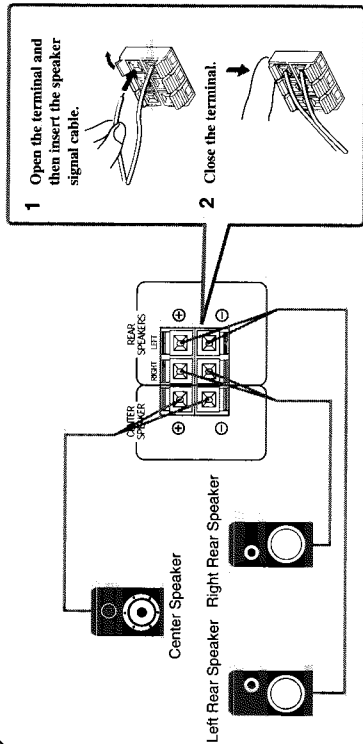
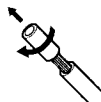

Notes:

- You can register the center speaker size after you finish its connection. If you register it, you do not have to set the center speaker mode when setting the surround mode. (If you do not use a center speaker, register that information.) See page 17.
- When you connect rear speakers, make sure that both left and right speakers are connected; otherwise, no sound will come out of the rear speakers.

Connecting the subwoofer speaker

You can enhance the bass by connecting a subwoofer. Connect the input jack of a powered subwoofer to the SUBWOOFER OUT jack on the rear panel using a cable with RCA pin plugs.

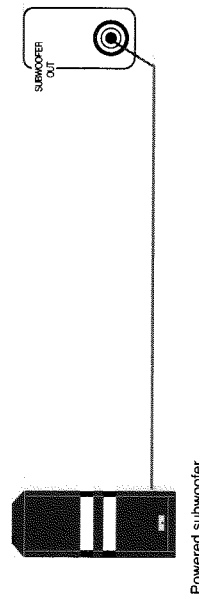

About the speaker impedance of the speakers

CAUTION: Use speakers with the SPEAKER IMPEDANCE indicated by the speaker terminals.

Notes:

- The required speaker impedance of the front speakers does not differ depending on whether both the FRONT SPEAKERS ① and FRONT SPEAKERS ② terminals are used or only one of them is used.
- The required speaker impedance of the front speakers differs depending on whether or not a center and/or rear speakers are connected at the same time. Since there are four possible speaker connections with the receiver, check which one fits your case and use the speaker with the impedance described below.

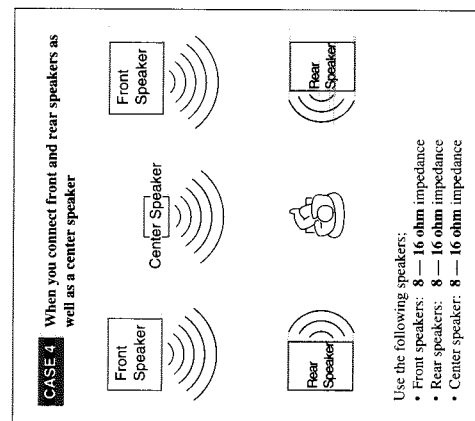
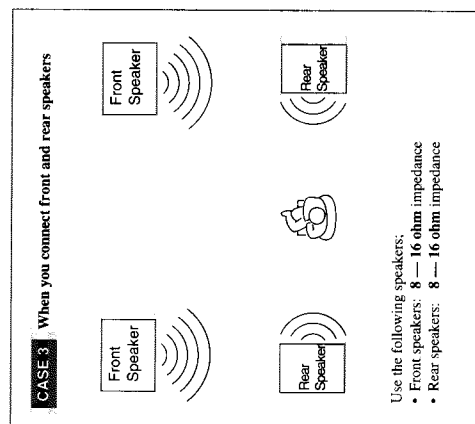
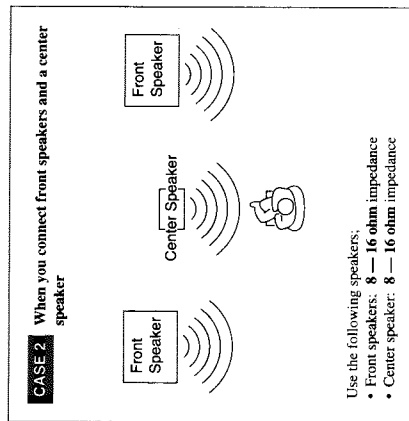
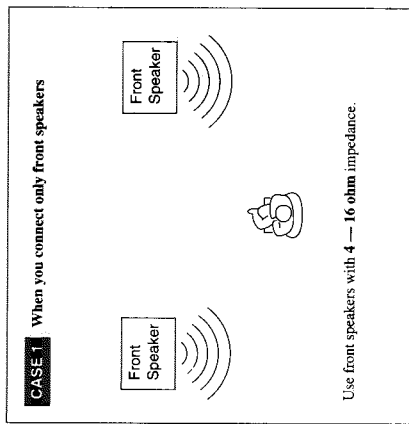

Video component connections

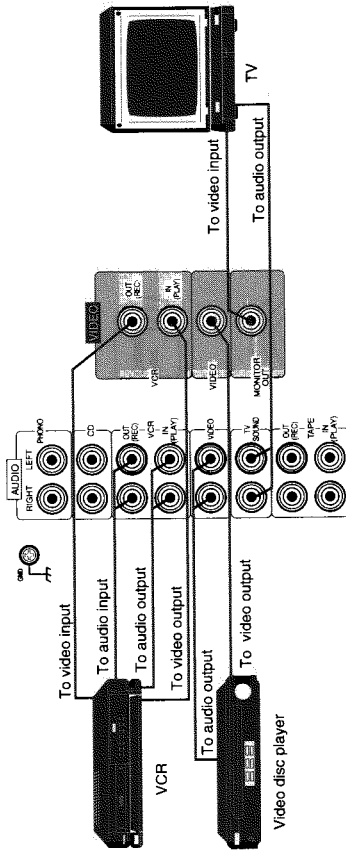

Connecting the Power Cord

Before plugging the receiver into an AC outlet, make sure that all connections have been made.

1. Plug the power cord into an AC outlet.
2. Press **POWER** to set it in the **ON** position. The **STANDBY** lamp lights up. A small amount of power is always consumed.



To shut off the power completely Press **POWER** to set it in the **OFF** position.

Keep the power cord away from the connecting cables for the TV, VCR, and antenna. The power cord may cause noise or screen interference. We recommend that you use a coaxial cable to connect the antenna, since it is well-shielded against interference.

The difference between the **POWER** switch and the **STANDBY/ON** button

- The **POWER** switch is the mains supply switch, allowing the receiver to connect to the mains supply. To shut off the power completely, press the **POWER** switch to set it in the **OFF** position.
- The **STANDBY/ON** button is a functional on/off (standby) switch, and does not disconnect the receiver from the mains supply. A small amount of power is consumed even in standby mode for the receiver to accept signals from the remote control.

Note:

- A preset settings such as preset channels and sound adjustments may be erased in the following cases:
 - When you press **POWER** to set it in the **OFF** position.
 - When you unplug the power cord.
 - When a power failure occurs.

CAUTIONS:

- Do not touch the power cord with wet hands.
- Do not pull on the power cord to unplug the cord. When unplugging the cord, always grasp the plug so as not to damage the cord.

Connecting Audio/Video Components

You can connect the following audio/video components to this receiver using cables with RCA pin plugs (not supplied). Refer also to the manuals supplied with your components. If you want to connect a component not listed in the table below, refer to the manual supplied with it.

Audio Components	Video Components
• Turntable	• TV
• CD player	• VCR
• Cassette deck	• Video disc player

Notes:

- If you connect a sound-enhancing device such as a graphic equalizer between the source components and this receiver, the sound output through this receiver may be distorted.
- Any turntables incorporating a small-output cartridge such as an MC (moving-coil type) must be connected to this receiver through a commercial head amplifier or step-up transformer. Direct connection may result in insufficient volume.

Audio component connections

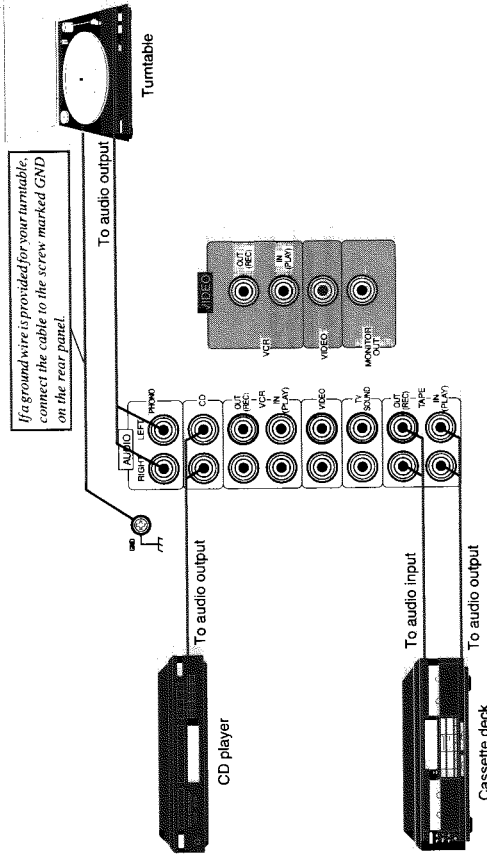

If a ground wire is provided for your turntable, connect the cable to the screw marked GND on the rear panel.

If your audio components have a **COMPU LINK-3** terminal

The **COMPU LINK** remote control system allows you to control other JVC audio components from the receiver or vice versa. Connect your audio components and the receiver with the cable (monaural mini-plug supplied with those components) as well as the connection above. For detailed information about the connection and the **COMPU LINK-3** remote control system, see page 35.

Note:

The **COMPU LINK-3** remote control system is the upgraded version of the **COMPU LINK-1** and **COMPU LINK-2**. Even if your component has the **COMPU LINK-1** or **COMPU LINK-2** jacks, you can still connect it in the **COMPU LINK-3** remote control system, but some functions may not work correctly.

Basic Operations

The following operations are commonly used when you play any sound source.

Turning the Power On and Off

On the front panel:

To turn on the power, press STANDBY/ON \odot /I. The STANDBY lamp goes off. The name of the current source (or station frequency) appears on the display.

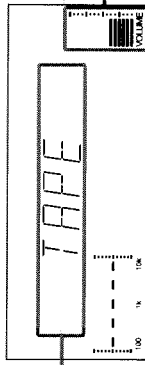

Current source name appears

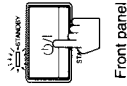

Front panel

To turn off the power (into standby mode), press STANDBY/ON \odot /I again. The STANDBY lamp lights up.

From the remote control:

To turn on the power, press AUDIO \odot /I. The STANDBY lamp goes off. The name of the current source appears on the display.



Remote Control

To turn off the power (into standby mode), press AUDIO \odot /I again. The STANDBY lamp lights up.

Note:

Pressing STANDBY/ON \odot /I or AUDIO \odot /I again turns off the power (into standby mode) and lights the STANDBY lamp. A small amount of power is consumed in standby mode. To turn the power off completely, press \odot POWER to set it in the **OFF** position on the front panel.

Selecting the Source to Play

You need to select the source before you start playing any source.

On the front panel:

1. Press SOURCE so that the Control Δ / ∇ buttons work for selecting the source.
2. Press Control Δ / ∇ until the source name you want appears on the display. The selected source lamp also lights up.

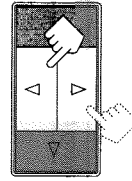
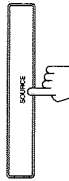

Front panel

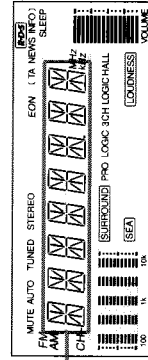

Selected source name appears

Putting Batteries in the Remote Control

Before using the remote control, put two supplied batteries first. When using the remote control, aim the remote control directly at the remote sensor on the receiver.

1. On the back of the remote control, remove the cover as illustrated.
2. Insert batteries. Make sure to observe the proper polarity: (+) to (+) and (-) to (-).
3. Replace the cover in.

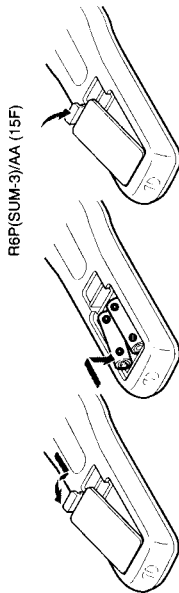

R6P(SUM-3)/AA (15F)

If the range or effectiveness of the remote control decreases, replace the batteries. Use two R6P(SUM-3)/AA (15F) type dry-cell batteries.

CAUTIONS:

- Follow these precautions to avoid leaking or cracking cells:
- Place batteries in the remote control so they match the polarity indicated: (+) to (+) and (-) to (-).
 - Use the correct type of batteries. Batteries that look similar may differ in voltage.
 - Always replace both batteries at the same time.
 - Do not expose batteries to heat or flame.

Listening with Headphones

A standard pair of headphones can be connected to the PHONES jack on the front panel.
To listen with only headphones, press both SPEAKERS 1 and 2 to set them in the OFF position. No sound comes out of the front speakers.

CAUTION:
 Be sure to turn down the volume before connecting or putting on headphones, as high volume can damage both the headphones and your hearing.

Muting the Sound



Remote Control

From the remote control only:

To mute the sound through all the speakers and headphones connected, press MUTE so that "MUTE" appears on the display and the volume turns off.

To cancel the mute, press MUTE again so that "OFF" appears on the display. Turning MASTER VOLUME or pressing VOLUME +/- also restores the sound at the previous volume level.

Recording a Source

You can record any source playing through the receiver to the cassette deck connected to the TAPE jacks and the VCR connected to the VCR jacks at the same time.
 While recording, you can listen to the selected sound source at whatever sound level you like, without affecting the sound levels of the recording.

Note:
 The output volume level, SEA, and surround adjustments cannot affect the recording.

From the remote control:

Press one of the source selecting buttons you want.
 VIDEO Play back a video source on the video component connected to the VIDEO jacks.
 VCR Play back a video source on the video component connected to the VCR jacks.
 TV SOUND Listen to TV sounds.
 FM/AM* Listen to the radio.
 TAPE* Listen to a cassette tape.
 CD* Listen to a CD.
 PHONO* Listen to a record.

Note:
 When you press one of the source selecting buttons marked above with an asterisk (*), the receiver automatically turns on.

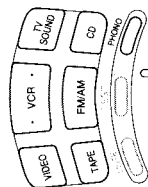

Remote Control

Adjusting the Volume

When you change the volume level, the volume level is shown on the display.

On the front panel:

To increase the volume, turn MASTER VOLUME clockwise.
To decrease the volume, turn MASTER VOLUME counterclockwise.

Note:
 When you turn MASTER VOLUME rapidly, the volume level also changes rapidly.
 When you turn MASTER VOLUME slowly, the volume level also changes slowly.

From the remote control:

To increase the volume, press VOLUME +.
To decrease the volume, press VOLUME -.

CAUTION:

Always set the volume level to the minimum before starting any source. If the volume level is left turned up, the sudden blast of sound energy can permanently damage your hearing and/or ruin your speakers.

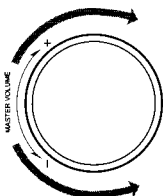

Front panel

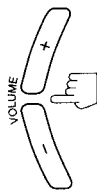

Remote Control

Selecting the Front Speakers

On the front panel only:

When you have connected two pairs of the front speakers, you can select which to use. Pressing SPEAKERS 1 or SPEAKERS 2 to set it in the ON position activates the respective pair of the speakers.

To use the speakers connected to the FRONT SPEAKERS 1 terminals, press SPEAKERS 1 to set it in the ON position, and press SPEAKERS 2 to set it in the OFF position.
To use the speakers connected to the FRONT SPEAKERS 2 terminals, press SPEAKERS 2 to set it in the ON position, and press SPEAKERS 1 to set it in the OFF position.

To use both pairs of the speakers, press both SPEAKERS 1 and 2 to set them in the ON position.
To use neither pair of the speakers, press both SPEAKERS 1 and 2 to set them in the OFF position.

Note:
 When only one pair of the speakers is connected to either the FRONT SPEAKERS 1 or 2 terminals, do not press both SPEAKERS 1 and 2 to set them in the ON position. If you do, no sound comes out of the front speakers.



Front panel

Basic Settings

Some of the following settings are required after connecting and positioning your speakers in your listening room, while others will make operations easier.

Adjusting the Front Speaker Output Balance

If the sounds you hear from the front right and left speakers are unequal, you can adjust the speaker output balance.

On the front panel only:

1. Press **SETTING** so that the Control $\Delta / \nabla / \triangleleft / \triangleright$ buttons work for adjusting the balance. The lamp next to the button lights up.
2. Press Control Δ / ∇ until "BALANCE" appears on the display.
3. Press Control $\triangleleft / \triangleright$ to adjust the balance.
 - Pressing Control \triangleleft decreases the right channel output.
 - Pressing Control \triangleright decreases the left channel output.

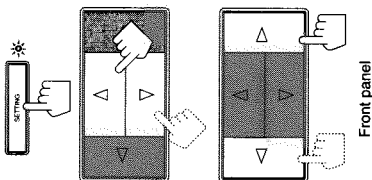

Front panel

Listening at Low Volume (Loudness)

Human ears are not sensitive to bass at low volume. To compensate for this, the loudness function automatically boosts the bass level as you lower the volume.

Note:
The loudness function affects the front speaker sounds only.

On the front panel only:

1. Press **SETTING** so that the Control $\Delta / \nabla / \triangleleft / \triangleright$ buttons work for setting the loudness function. The lamp next to the button lights up.
2. Press Control Δ / ∇ until "LOUDNESS" appears on the display.
3. Press Control $\triangleleft / \triangleright$ to set the loudness function to "ON" or "OFF."
 - Select "ON" to activate the loudness function.
 - The LOUDNESS indicator lights up on the display.
 - Select "OFF" to cancel it.
 - The indicator goes off.

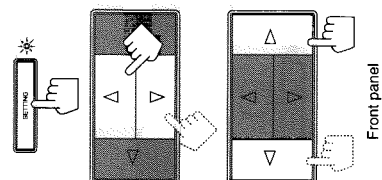

Front panel

Using the Sleep Timer

Using the Sleep Timer, you can fall asleep to music and know the receiver will turn off by itself rather than play all night.

On the front panel:

1. Press **SETTING** so that the Control $\Delta / \nabla / \triangleleft / \triangleright$ buttons work for setting the Sleep Timer. The lamp next to the button lights up.
2. Press Control Δ / ∇ until "<SLEEP>" appears on the display.
3. Press Control $\triangleleft / \triangleright$ to set the shut-off time. Each time you press the button, the shut-off time on the display changes as follows: The SLEEP indicator lights up on the display.

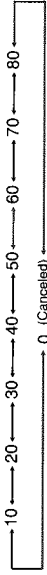

When the shut-off time comes

The receiver turns off (into standby mode) automatically.

To check or change the time remaining until the shut-off time

1. Press **SETTING**, if necessary, so that the Control $\Delta / \nabla / \triangleleft / \triangleright$ buttons work for setting the Sleep Timer.
2. Press Control Δ / ∇ , if necessary, until "<SLEEP>" appears on the display.
3. Press Control $\triangleleft / \triangleright$ once. The remaining time until the shut-off time appears in minutes.
 - To change the shut-off time, press Control $\triangleleft / \triangleright$ repeatedly.

To cancel the Sleep Timer

Press Control $\triangleleft / \triangleright$ repeatedly in step 3 above until "0" appears on the display. (The SLEEP indicator goes off.) Turning off the power (into standby mode) also cancels the Sleep Timer.

From the remote control:

Press **SLEEP** repeatedly.

The SLEEP indicator lights up and the shut-off time appears on the display. Each time you press the button, the shut-off time on the display changes as follows:

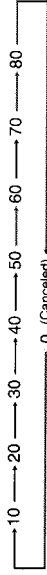

Remote Control

To check or change the time remaining until the shut-off time

Press SLEEP once. The remaining time until the shut-off time appears in minutes.

- To change the shut-off time, press SLEEP repeatedly.

To cancel the Sleep Timer

Press SLEEP repeatedly until "0" appears on the display. (The SLEEP indicator goes off.) Turning off the power (into standby mode) also cancels the Sleep Timer.

One Touch Operation

This receiver can memorize the optimum sound settings for each playing source.

About the One Touch Operation

JVC's One Touch Operation function is used to assign and store different sound settings for each different playing source. By using this function, you don't have to change the settings every time you change the source. The stored settings for the newly selected source are automatically recalled.

The following can be stored for each source:

- Volume level (see page 13)
- Balance (see page 15)
- Loudness (see page 15)
- SEA modes (see page 26)
- Surround mode settings (see page 28)

Note:

If the source is FM or AM (MW/LW), the One Touch Operation function works only when the preset channels from 1 — 20 are tuned in. You can assign a different setting for each preset channel.

Using the One Touch Operation

To store the sound settings

1. Press ONE TOUCH OPERATION. The ONE TOUCH OPERATION lamp lights up, then the previously memorized settings are recalled and appear on the display in turn.
2. Adjust the sound using the functions listed above. The newly adjusted settings are memorized.

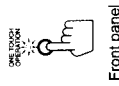

Front panel

To recall the sound settings

With the ONE TOUCH OPERATION lamp lit, the settings for the currently selected source is recalled, and appears on the display when the source is selected.

To cancel the One Touch Operation function

Press ONE TOUCH OPERATION so that the lamp goes off. (Even though the One Touch Operation function is canceled, the recalled sound effects remain active.)



Remote Control

Selecting the Center Speaker Size

You can register the information on the center speaker after all connections are completed. If you do this registration first, you do not have to adjust the center speaker mode when you want to activate the Dolby surround. However, to register the information, first you have to set the surround mode either to "PROLOGIC" or "3CHLOGIC." (You cannot select the center speaker size when the surround mode is "SURR OFF" or "HALL.")

On the front panel only:

1. Press SURROUND MODE so that the Control Δ / ▽ buttons work for selecting the surround mode. The lamp next to the button lights up.
2. Press Control Δ / ▽ until "PROLOGIC" or "3CHLOGIC" whichever you want appears on the display. The PRO LOGIC or 3CH LOGIC indicator (as well as the SURROUND indicator) also lights up.
3. Press SETTING so that the Control Δ / ▽ / ◀ / ▶ buttons work for selecting the center speaker size. The lamp next to the button lights up.
4. Press Control Δ / ▽ until "CNTR SPK" (Center Speaker) appears on the display.
5. Press Control ◀ / ▶ to select the appropriate item about your center speaker. Each time you press the button, the display changes to show the following.

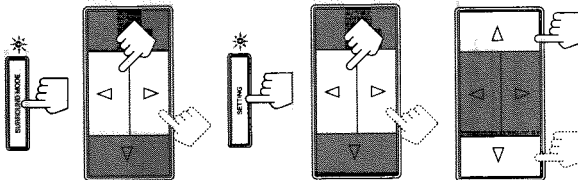

Front panel

LARGE:	Select this mode when the size of the center speaker is the same as that of the front speakers.
SMALL:	Select this mode when the size of the center speaker is smaller than that of the front speakers.
NO:	Select this mode when you do not use a center speaker. (You cannot select this mode when "3CHLOGIC" is selected for the surround mode.)

Note:

This center speaker size setting is so related to the center mode setting for the Dolby Surround mode that changing this setting affects and changes the center mode to a relevant mode, and vice versa.

- For example:
- If you select "LARGE," the center mode is automatically set to "WIDE," and vice versa.
 - If you select "SMALL," the center mode is automatically set to "NORMAL," and vice versa.
 - If you select "NO," the center mode is automatically set to "PHANTOM," for Pro Logic, and vice versa.

Receiving Radio Broadcasts

You can browse through all the stations or use the preset function to go immediately to a particular station.

Tuning in Stations Manually

On the front panel only:

1. Press **TUNER** so that the Control Δ / ∇ / \triangleleft / \triangleright buttons work for tuner settings. The lamp next to the button lights up.
2. Press Control Δ / ∇ until “<FM AML>” appears on the display.
3. Press Control \triangleleft / \triangleright to select the band. Each time you press the button, the band alternates between FM and AM (MW/LW).
4. Press Control Δ / ∇ until “<TUNING+>” appears on the display.
5. Press Control \triangleleft / \triangleright until you find the frequency you want.
 - Pressing Control \triangleleft decreases the frequency.
 - Pressing Control \triangleright increases the frequency.

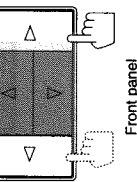

Front panel

- Notes:**
- When you hold down Control \triangleleft / \triangleright in step 5, the frequency keeps changing until you press the button again or a station is tuned in.
 - When a station of sufficient signal strength is tuned in, the TUNED indicator lights up on the display. When an FM stereo program is received, the STEREO indicator also lights up.

Using Preset Tuning

Once a station is assigned to a channel number, the station can be quickly tuned. You can preset up to 40 stations at random.

Storing the preset stations

On the front panel only:

1. Tune in the station you want to preset (see above). If you want to store the FM reception mode for this station, select the FM reception mode you want. See page 20 for details.
2. Press **MEMORY** (next to the TUNER button). “CH.” appears and the channel number position starts flashing on the display for about 5 seconds.
3. Press Control Δ / ∇ to select a channel number while the channel number position is flashing.
 - Pressing Control Δ increases the number.
 - Pressing Control ∇ decreases the number.

Note:
You can use the 10 keys on the remote control to select the preset number. When using the 10 keys, be sure that they are activated for tuner, not for the CD and others. (See page 36.)

4. Press **MEMORY** (next to the TUNER button) again while the selected channel number is flashing on the display. The selected channel number stops flashing. The station is assigned to the selected channel number.

5. Repeat steps 1 to 4 until you store all the stations you want. To cancel a stored preset station
Storing a new station on a used number erases the previously stored one.

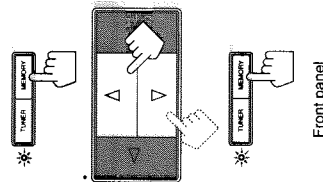

Front panel

CAUTION:

- The preset channels may be erased in the following cases:
- When you press \square POWER to set it in the \blacksquare OFF position.
 - When you unplug the power cord.
 - When a power failure occurs.

Tuning in a preset station

On the front panel:

1. Press **TUNER** so that the Control Δ / ∇ / \triangleleft / \triangleright buttons work for tuner settings. The lamp next to the button lights up.
2. Press Control Δ / ∇ until “<PRESET+>” appears on the display.
3. Press Control \triangleleft / \triangleright to select a preset channel. Each time you press the button, the preset channels changes.
 - Pressing Control \triangleleft changes preset channels in decreasing order.
 - Pressing Control \triangleright changes preset channels in increasing order.

From the remote control:

1. Press **FM/AM**. Each time you press the button, the band alternates between FM and AM (MW/LW).
2. Press 10 keys to select a preset channel number.
 - For channel number 5, press 5.
 - For channel number 15, press +10 then 5.
 - For channel number 20, press +10 then 10.
 - For channel number 30, press +10, +10, then 10.

Note:

When you use the 10 keys on the remote control, be sure that they are activated for tuner, not for the CD and others. (See page 36.)

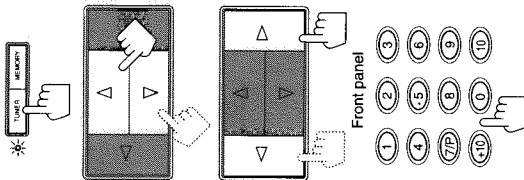

Front panel

Remote Control

Selecting the FM Reception Mode

You can change the FM reception mode while listening an FM broadcast. You can also store the FM reception mode for each preset station. (See page 19.)

On the front panel only:

1. Press **TUNER** so that the Control Δ / ∇ / \triangleleft / \triangleright buttons work for tuner settings. The lamp next to the button lights up.
2. Press Control Δ / ∇ until “<FM MODE>” appears on the display.
3. Press Control \triangleleft / \triangleright to select either “<AUTO>” or “<MONO>”.
 - Normally select “<AUTO>.”
 - When an FM stereo broadcast is hard to receive or noisy, select “<MONO>.”

AUTO:	When a program is broadcast in stereo, you will hear stereo sound; when in monaural, you will hear monaural sounds. This mode is also useful to suppress static noise between stations. The MUTE AUTO indicator lights up on the display.
MONO:	Reception will be improved although you will lose the stereo effect. In this mode, you will hear noise while tuning into the stations. The MUTE AUTO indicator goes off on the display.

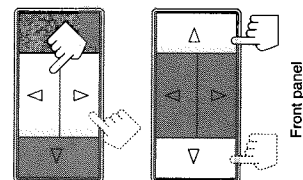

Front panel

Assigning Names to Preset Stations

You can assign a name of up to five characters to each preset station (from preset channel number 1 to 20). When a preset station is tuned in, its assigned name will appear on the display.

On the front panel only:

1. **Tune in a preset station (preset channel number 1 to 20).**
See page 20 for details.
 2. **Press MEMORY (next to the TUNER button).**
The preset channel number starts flashing.
- Note:*
If you press Control Δ / ▽ while the preset channel number is flashing, you can change the preset channel number.
3. **Press Control ▷ (or ◀) until the first character position starts flashing.**
 4. **Press Control Δ / ▽ to select a character.**
You can use the characters listed below.
 5. **When a character you want appears, press Control ▷ (or ◀).**
The next (or previous) character position starts flashing.
 6. **Repeat steps 4 and 5 to enter up to five characters.**
 7. **Press MEMORY (next to the TUNER button) again, while the last selected character is flashing, after you have assigned a name.**

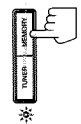
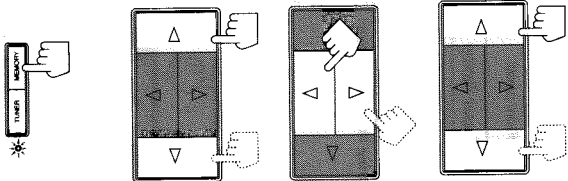

Front panel

To erase the input characters
Insert blanks using the same procedure described above.

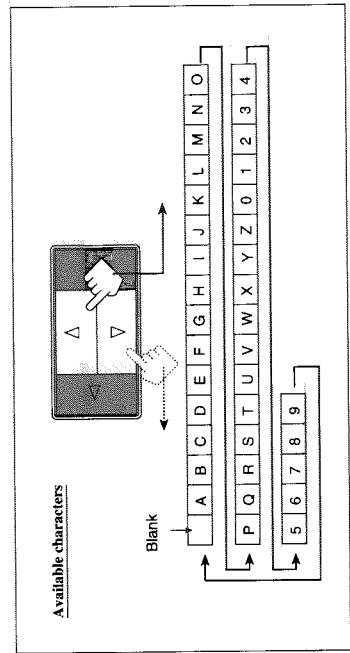

Using the RDS (Radio Data System) to Receive FM Stations

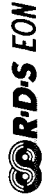

RDS allows FM stations to send an additional signal along with their regular program signals. For example, the stations send their station names, as well as information about what type of program they broadcast, such as sports or music, etc.

When tuned to an FM station which provides the RDS service, the RDS indicator lights up on the display.

- With the receiver, you can receive the following types of RDS signals.
- PS (Program Service): shows commonly known station names
 - PTY (Program Type): shows types of broadcast programs
 - RT (Radio Text): shows text messages the station sends

About characters shown on the display

When the display shows PS, PTY, or RT signals, the following characters are used.

- The display cannot differentiate upper case and lower case letters and always uses upper case letters.
- The display cannot show accented letters, "A", for instance, may stand for accented "A's" like "Á, Â, Ã, Ä, Å, and A."

H	A	A	A	K	S	U	U	U	U	0	'	'
B	A	A	A	A	A	V	V	V	V	1	1	1
C	C	C	C	M	W	2	2	2	2	-	-	-
D	0	0	0	N	A	X	X	X	X	3	3	3
E	E	E	E	0	0	0	0	0	0	4	4	4
F	F	F	F	0	0	0	0	0	0	5	5	5
G	G	G	G	0	0	0	0	0	0	6	6	6
H	H	H	H	R	R	R	R	R	R	7	7	7
I	I	I	I	5	5	5	5	5	5	8	8	8
J	J	J	J	7	7	7	7	7	7	9	9	9

Note:
RDS may not operate correctly if the station tuned is not transmitting data properly or if the signal strength is weak.

What Information Can RDS Signals Provide?

You can see the RDS signals the station sends.

To show the RDS signals

Press **DISPLAY MODE** while listening to an FM station.

Each time you press the button, the display changes to show you the following information:



PS (Program Service):

While searching, "PS" appears and then the station names will be displayed. "NO PS" appears if no signal is sent.

PTY (Program Type):

While searching, "PTY" appears and then the type of the broadcast program will be displayed. "NO PTY" appears if no signal is sent.

RT (Radio Text):

While searching, "RT" appears and then text messages the station sends will be displayed. "NO RT" appears if no signal is sent.

Station Frequency:

Station frequency (non-RDS service)

To be continued to the next page

When pressing DISPLAY MODE on the remote control:

Make sure that you have selected FM station using the remote control only. If not, the DISPLAY MODE button does not work for tuner operation. (Pressing FM/AM activates the remote control for tuner operation.)

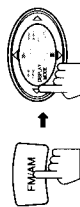

Remote control

Notes:

- If searching finishes at once, "PS", "PTY", and "RT" will not appear on the display.
- If you press DISPLAY MODE while listening to an AM (MW/LW) station, the display only shows station frequency.
- RDS is not available for AM (MW/LW) broadcasts.

Searching for a Program by PTY Codes

One of the advantages of the RDS service is that you can locate a particular kind of program from the preset channels by specifying the PTY codes.

To search for a program using the PTY codes

On the front panel:

1. Press **PTY SEARCH** while listening to an FM station so that **Control </>** buttons work for selecting PTY code. "PTY" and "SELECT" alternate on the display.



Remote Control

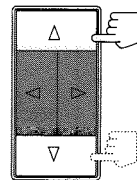

Front panel

2. Press **Control </>** until the **PTY code** you want appears on the display. Each time you press the button, the display gives you the PTY codes described on page 24.

3. Press **PTY SEARCH** again.

While searching, "SEARCH" and the selected PTY code alternate on the display. The receiver searches 40 preset channels, stops when it finds the one you have selected, and tunes in that station.

To continue searching after the first stop

Press **PTY SEARCH** again while the indications on the display are flashing. If no program is found, "NOTFOUND" appears on the display.

To stop searching any time during the process

Press **PTY SEARCH** while searching.

From the remote control:

Before starting the procedure below, make sure you have selected FM station only using the remote control. If not, the following RDS operating buttons do not work for tuner operation. (Pressing FM/AM activates the remote control for tuner operation.)

1. Press **PTY SEARCH** while listening to an FM station. "PTY" and "SELECT" alternate on the display.
2. Press **PTY +/-** until the **PTY code** you want appears on the display. The display gives you the PTY codes described below.
3. Press **PTY SEARCH** again. While searching, "SEARCH" and the selected PTY code alternate on the display. The receiver searches 40 preset channels, stops when it finds the one you have selected, and tunes in that station.

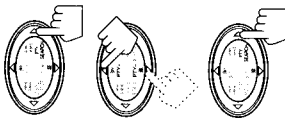

To continue searching after the first stop

Press **PTY SEARCH** again while the indications on the display are flashing. If no program is found, "NOTFOUND" appears on the display.

To stop searching any time during the process

Press **PTY SEARCH** while searching.

Descriptions of the PTY codes:

- NEWS:** News
- AFFAIRS:** Topical programs expanding on the current news or affairs
- INFO:** Programs on medical service, weather forecast, etc.
- SPORT:** Sports events
- EDUCATE:** Educational programs
- DRAMA:** Radio plays
- CULTURE:** Programs on national or regional culture
- SCIENCE:** Programs on natural sciences and technology
- VARIED:** Other programs like comedies or ceremonies
- POP M:** Pop music
- ROCK M:** Rock music
- M.O.R. M:** Middle-of-the-road music (usually called "easy listening")
- LIGHT M:** Light music
- CLASSICS:** Classics
- OTHER M:** Other music
- ALARM:** Emergency broadcast
- NONE:** Undefined (this cannot be searched.)

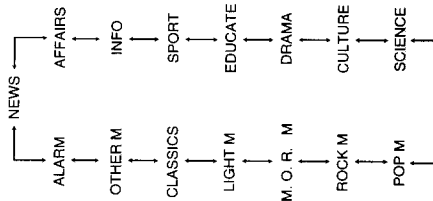

When an emergency broadcast (ALARM signal) is sent from an FM station:

The receiver automatically switches the source to FM and tunes in the station except in the following cases:

- When you are listening to non-RDS stations (all AM (MW/LW) and some FM stations).
- When the receiver is in standby mode.

While receiving an emergency broadcast, "ALARM" appears on the display.

Using the SEA Modes

The SEA (Sound Effect Amplifier) modes give you control of the way your music sounds.

Note: The SEA modes cannot be used for recording.

Selecting Your Favorite SEA Mode

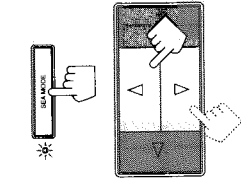

On the front panel:

- 1. Press SEA MODE so that the Control Δ / ▽ buttons work for selecting the SEA mode. The lamp next to the button lights up.
2. Press Control Δ / ▽ until the mode you want appears on the display. Each time you press the button, the SEA mode changes as follows:

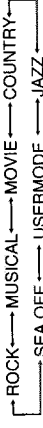

Note: When the SEA mode is turned on, the SEA indicator lights up on the display.

Table with 2 columns: SEA Mode and Description. Rows include ROCK, MUSICAL, MOVIE, COUNTRY, JAZZ, USERMODE, and SEA OFF.

To cancel the SEA mode, press Control Δ / ▽ until "SEA OFF" appears in step 2 above. The SEA indicator goes off from the display.

From the remote control:

Press SEA MODE repeatedly until the SEA mode you want appears on the display. Each time you press the button, the SEA mode changes as follows:



Note: When the SEA mode is turned on, the SEA indicator lights up on the display.

To cancel the SEA mode, press SEA MODE repeatedly until "SEA OFF" appears on the display. The SEA indicator goes off from the display.

Switching to a Broadcast Program of Your Choice Temporarily

Another convenient RDS service is called "EON (Enhanced Other Network)." This allows the receiver to switch temporarily to a broadcast program of your choice (NEWS, TA, and/or INFO) from a different station except in the following cases:
- When you are listening to a non-RDS station (all AM (MW/LW) and some FM stations).
- When the last received FM station is a non-RDS station.

On the front panel only:

- 1. Press EON so that the last selected program type appears on the display. The receiver enters EON standby mode.
2. Press TA/NEWS/INFO until the program type you want appears on the display. Each time you press the button, the display changes to show the following:

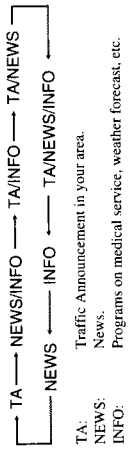

TA: Traffic Announcement in your area.
NEWS: News.
INFO: Programs on medical service, weather forecast, etc.

CASE 1: If there is no station broadcasting the program you have selected. CASE 2: If there is a station broadcasting the program you have selected. Includes flowcharts for both cases.

To stop listening to the program selected by EON:

Press EON so that the program type (TA/NEWS/INFO) goes off from the display. The receiver enters EON off mode and goes back to the previously selected source. Each time you press EON, the EON mode alternates between standby mode and off mode.

Notes:

- In EON standby mode, if you change the source to AM (MW/LW) or if you carry out synchronized recording (see page 35), EON standby mode is canceled temporarily. The receiver goes back to EON standby mode again when you have finished that operation.
- While listening to a program tuned in by the EON function, you can only use STANDBY/ON OFF, EON, and DISPLAY MODE on the front panel or AUDIO Q1 and DISPLAY MODE on the remote control.
- When the receiver is turned off (into standby mode), the EON function is also turned off.

CAUTION:

When the source alternates intermittently between the station tuned in by the EON function and the currently selected source, press EON to cancel the EON function. This is not a malfunction of the receiver.



Front panel

Remote Control

Using the Surround Processor

The built-in surround processor provides three types of surround programs — Dolby Pro Logic, Dolby 3-Channel Logic, and JVC's Hall Surround.

What is surround?

The sound heard in a concert hall or a movie theater consists of direct sound and indirect sound: early reflections and reflections from behind. The reflected sounds are always delayed by the distances of the ceiling and walls from the listener. These reflections are some of the most important elements of the acoustic surround.

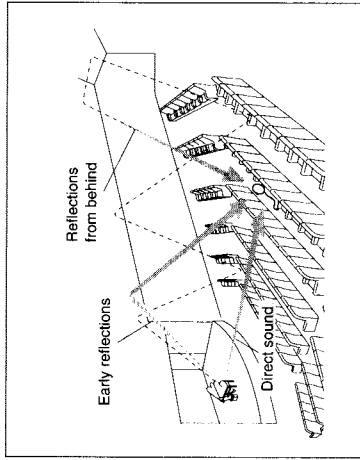

On JVC's Hall Surround

In order to reproduce a more realistic sound field in your listening room while playing an ordinary stereo source, JVC's Hall Surround has been designed to give you clear vocals and to create the feeling of a concert hall. The sound is reproduced through the front speakers and rear speakers.

On Dolby Surround

Dolby Surround has been also developed to reproduce the important elements of the acoustic surround at home. To watch the soundtracks of video software bearing the mark **DOLBY SURROUND** * which includes the same encoded surround information as found in Dolby Stereo films, the receiver can provide you with 2 Dolby Surround programs (Dolby Pro Logic and Dolby 3ch Logic).

Dolby Pro Logic: Select this mode when the optional rear speakers are connected (as well as a center speaker).
Dolby 3ch Logic: Select this mode when a center speaker is connected without rear speakers.

Notes:

- The surround processor has no effect on monaural sources.
- The surround processor cannot be used for recording.

* Manufactured under license from Dolby Laboratories Licensing Corporation. "Dolby," the double-D symbol, and "Pro Logic" are trademarks of Dolby Laboratories Licensing Corporation.

Using JVC's Hall Surround

You need to connect one set of rear speakers to obtain the full effect. Once you have adjusted the Hall Surround, the receiver memorizes the settings.

On the front panel:

1. Press **SURROUND MODE** so that the Control Δ / ∇ buttons work for selecting the surround modes.
The lamp next to the button lights up.
2. Press Control Δ / ∇ until "HALL" appears on the display.
The HALL and SURROUND indicators also light up on the display.
Each time you press the button, the surround modes change as follows (the indicator of the selected surround mode also lights up on the display):

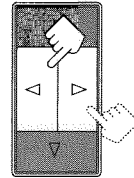
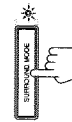

Front panel



To be continued to the next page

Creating Your Own SEA Mode

You can adjust and store your own SEA adjustment into memory (USERMODE).

On the front panel only:

If you do not want to store your adjustment, but rather want to adjust the SEA temporarily, skip step 3 below.

1. Press **SEA ADJUST** so that the Control Δ / ∇ / \triangleleft / \triangleright buttons work for the SEA adjustment.
The lamp next to the button lights up.
2. Adjust the SEA frequency and its level.
 - Press Control \triangleleft / \triangleright to select the frequency range to adjust.
 - Press Control Δ / ∇ to adjust the level.

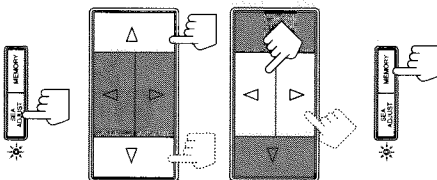
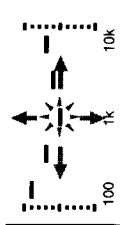

Front panel

3. Press **MEMORY** (next to the SEA ADJUST button).
Your adjustment is stored into USERMODE.

To recall your own SEA adjustment

See page 26.

To erase a stored adjustment

Storing a new adjustment into USERMODE erases the previously stored one.

Speaker Arrangements for Dolby Surround

The following illustrations show how to obtain the optimum sound environment for various Dolby Surround settings. Try to find the speaker direction and location to create the optimum sound field.

CASE 1 When you have added a center speaker and rear speakers

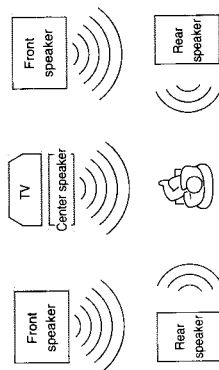

In this case:
 1. Select "PROLOGIC."
 2. Select "NORMAL" or "WIDE" for center mode.
 See pages 31 to 33 for more details.

CASE 2 When you have added rear speakers (without a center speaker)

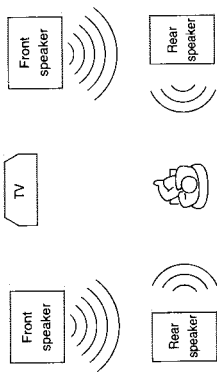

In this case:
 1. Select "PROLOGIC."
 2. Select "PHANTOM" for center mode.
 See pages 31 to 33 for more details.

CASE 3 When you have added a center speaker (without rear speakers)

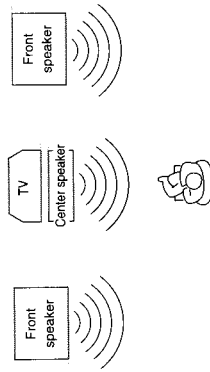

In this case:
 1. Select "3CHLOGIC."
 2. Select "NORMAL" or "WIDE" for center mode.
 See pages 31 to 33 for more details.

3. Press SURROUND ADJUST so that the Control Δ / ▽ / ◁ / ▷ buttons work for surround settings.

The lamp next to the button lights up.

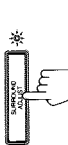

4. Press Control Δ / ▽ until "REAR +" appears on the display.

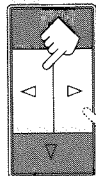

- Pressing Control ◁ / ▷ decreases the output level up to -10 dB.
- Pressing Control ▷ increases the output level up to +10 dB.

6. Press Control Δ / ▽ until "-DELAY +" appears on the display.

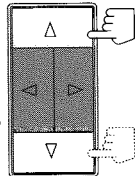

- Pressing Control ◁ / ▷ to adjust the rear speaker output. Each time you press the button, the delay time changes as follows:
 DELAY 1 → DELAY 2 → DELAY 3 → DELAY 4

DELAY 1:	Select this when the distance from you to your rear speakers is greater than that to the front speakers.
DELAY 2:	Select this when the distance from you to your rear speakers is almost equal to that to the front speakers.
DELAY 3:	Select this when the distance from you to your rear speakers is a little less than that to the front speakers.
DELAY 4:	Select this when the distance from you to your rear speakers is much less than that to the front speakers.

To cancel the Hall surround, press Control Δ / ▽ until "SURR OFF" appears in step 2. The HALL and SURROUND indicators go off.

From the remote control:

- Press ON/OFF so that the SURROUND indicator lights up on the display.**
 The previous surround mode is recalled (at its previous settings) and is shown on the display. Each time you press the button, the surround mode turns on and off.
- Press MODE repeatedly until "HALL" appears on the display.**
 Each time you press the button, the surround modes change as follows (the indicator of the selected surround mode also lights up on the display):
 PROLOGIC → 3CHLOGIC → HALL → SURR OFF (Surround Off)
- Press REAR +/- to adjust the rear speaker output level.**
 • Pressing REAR - decreases the output level up to -10 dB.
 • Pressing REAR + increases the output level up to +10 dB.
- Press DELAY to adjust the delay time.**
 Each time you press the button, the delay time changes as follows:
 DELAY 1 → DELAY 2 → DELAY 3 → DELAY 4

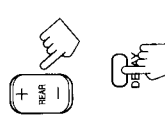
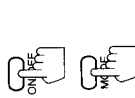

Remote Control

To cancel the Hall Surround, press ON/OFF again so that the HALL and SURROUND indicators go off. Selecting "SURR OFF" in step 2 above also cancels the Dolby Surround.

Preparing for Dolby Surround

The receiver memorizes two sets of Dolby Surround adjustments; one for Pro Logic and the other for 3ch Logic.

On the front panel:

1. Press **SURROUND MODE** so that the **Control Δ / ▽** buttons work for selecting the surround modes.
The lamp next to the button lights up.
2. Press **Control Δ / ▽** until "PROLOGIC" or "3CHLOGIC", whichever you want appears on the display.
The PRO LOGIC or 3CH LOGIC indicator (as well as the SURROUND indicator) also lights up. Each time you press the button, the surround modes change as follows (the indicator of the selected surround mode also lights up on the display):

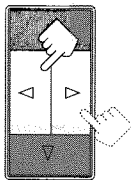

PROLOGIC:	Select this mode to watch a video source with Dolby Surround when you have connected the rear speakers (and a center speaker).
3CHLOGIC:	Select this mode to watch a video source with Dolby Surround when you have connected a center speaker and no rear speakers.
HALL:	This is JVC's original surround mode, and is different from Dolby Surround. To use this, see page 28.
SURR OFF:	No surround mode is applied.

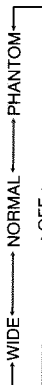
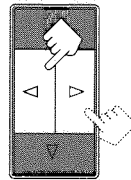
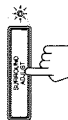

3. Press **SURROUND ADJUST** so that the **Control Δ / ▽ / ◀ / ▶** buttons work for adjusting the surround mode.
The lamp next to the button lights up.
4. Press **Control Δ / ▽** until "CNT MODE" (Center Mode) appears on the display.
5. Press **Control ◀ / ▶** to select the center mode.
Each time you press the button, the center modes change as follows:

WIDE:	Select this mode when the center speaker can reproduce the bass better than the front speakers. All signals of the center channel are output through the center speaker.
NORMAL:	Select this mode when the center speaker cannot reproduce the bass better than the front speakers. The bass portions of the center channel signals are output through the front speakers.
PHANTOM:	Select this mode when you do not use a center speaker. The center speaker channel signals are output through the front speakers.
OFF:	Select this mode to turn off the center speaker channel.

Notes:

- If you have already set the "center speaker size" following the procedure described on page 17, you do not have to select the center mode in this procedure.
- When you have selected "3CHLOGIC", you cannot select "PHANTOM."

Front panel

6. Press **Control Δ / ▽** until "DELAY +" appears on the display.
7. Press **Control ◀ / ▶** to adjust the delay time of the rear speaker output.
Each time you press the button, the delay time changes as follows:

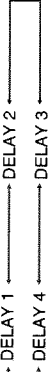

DELAY 1:	Select this when the distance from you to your rear speakers is greater than that to the front speakers.
DELAY 2:	Select this when the distance from you to your rear speakers is almost equal to that to the front speakers.
DELAY 3:	Select this when the distance from you to your rear speakers is a little less than that to the front speakers.
DELAY 4:	Select this when the distance from you to your rear speakers is much less than that to the front speakers.

Note: When you have selected "3CHLOGIC", you cannot adjust the delay time.

8. Press **Control Δ / ▽** until "TEST" appears on the display, then press **Control ◀ / ▶** to start checking the speaker output balance.
"TEST" starts flashing on the display, and a test tone comes out of the speakers in the following order:

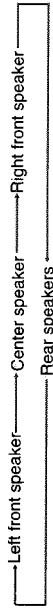

Notes:

- No test tone comes out of the rear speakers when you have selected "3CHLOGIC."
 - No test tone comes out of the center speaker when you select "PHANTOM" or "OFF" for the center mode.
9. If necessary, adjust the speaker output level as follows:
To adjust the rear speaker output level, press **Control Δ / ▽** until "REAR +" appears on the display, then press **Control ◀ / ▶**.
To adjust the center speaker output level, press **Control Δ / ▽** until "CENTER+" appears on the display, then press **Control ◀ / ▶**.

Notes:

- You cannot adjust the left and right rear speaker output level separately.
- You cannot adjust the rear speaker output level when you have selected "3CHLOGIC."
- You cannot adjust the center speaker output level when you select "PHANTOM" or "OFF" for the center mode.

10. Press **Control Δ / ▽** until "TEST" appears on the display, then press **Control ◀ / ▶** to stop the test tone.

11. Press **Control Δ / ▽** until "CNT TONE" (Center Tone) appears on the display.

12. Press **Control ◀ / ▶** to select the center tone you want.

The center tone adjustment affects the mid-frequency range, which the human voice is mostly made up of.
Each time you press the button, the display changes to show the following:

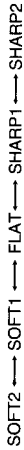

To make the dialogue clearer, select "SHARP1" (little) or "SHARP2" (much).

To make the dialogue softer, select "SOFT1" (little) or "SOFT2" (much).

When "FLAT" is selected, no adjustment is applied.

Note:

The center tone cannot be adjusted when sounds do not come out of the center speaker.

Using Dolby Surround

Once you have set the Dolby Surround adjustments, you can use the same adjustment every time you want to enjoy Dolby Surround.
The receiver memorizes two sets of Dolby Surround adjustment: one for Pro Logic and the other for 3ch Logic.

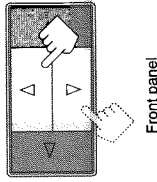
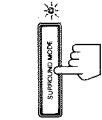

1. Press SURROUND MODE so that the Control Δ / ▽ buttons work for selecting the surround modes.
The lamp next to the button lights up.
2. Press Control Δ / ▽ until "PROLOGIC" or "3CHLOGIC" whichever you want appears on the display.
The PRO LOGIC or 3CH LOGIC indicator (as well as the SURROUND indicator) also lights up.
Each time you press the button, the surround modes change as follows (the indicator of the selected surround mode also lights up on the display):
PROLOGIC → 3CHLOGIC → SURR OFF (Surround Off) → HALL
3. Select and play a sound source which was processed with Dolby Surround and is labeled with mark.

To cancel the surround mode, press Control Δ / ▽ until "SURR OFF" appears in step 2. above.
The indicator of the selected mode and the SURROUND indicator go off.

From the remote control:

1. Press ON/OFF so that the SURROUND indicator lights up on the display.
The previous surround mode is recalled (at its previous settings) and is shown on the display.
Each time you press the button, the surround mode turns on and off.
2. Press MODE until the surround mode you want appears on the display.
Each time you press the button, the surround modes change as follows (the indicator of the selected surround mode also lights up on the display):
PROLOGIC → 3CHLOGIC → SURR OFF (Surround Off) → HALL
3. Select and play a sound source which was processed with Dolby Surround and is labeled with mark.



Remote Control

To cancel the surround mode, press ON/OFF again so that the indicator of the selected mode and the SURROUND indicator go off.
Selecting "SURR OFF" in step 2. above also cancels the Dolby Surround.

From the remote control:

Note:
You cannot adjust the center mode and the center tone using the remote control.

1. Press ON/OFF so that the SURROUND indicator lights up on the display.
The previous surround mode is recalled (at its previous settings) and is shown on the display.
Each time you press the button, the surround mode turns on and off.
2. Press MODE until "PROLOGIC" or "3CHLOGIC" whichever you want appears on the display.
Each time you press the button, the surround modes change as follows (the indicator of the selected surround mode also lights up on the display):
PROLOGIC → 3CHLOGIC → SURR OFF (Surround Off) → HALL
3. Press DELAY to adjust the delay time of the rear speaker output.
Each time you press the button, the delay time changes as follows:
DELAY 1 → DELAY 2 → DELAY 3 → DELAY 4 → HALL



Note:
When you have selected "3CHLOGIC," you cannot adjust the delay time.

4. Press TEST to start checking the speaker output balance.
"TEST" starts flashing on the display, and a test tone comes out of the speakers in the following order:
Left front speaker → Center speaker → Right front speaker → Rear speakers



Notes:

- No test tone comes out of the rear speakers when you have selected "3CHLOGIC."
- No test tone comes out of the center speaker when you select "PHANTOM" or "OFF" for the center mode.

5. If necessary, adjust the speaker output level as follows:

- To adjust the rear speaker output level, press REAR +/-.
- To adjust the center speaker output level, press CENTER +/-.

Pressing - decreases the output level up to -10 dB.
Pressing + increases the output level up to +10 dB.

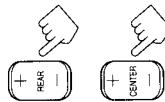

Notes:

- You cannot adjust the left and right rear speaker output level separately.
- You cannot adjust the rear speaker output level when you have selected "3CHLOGIC."
- You cannot adjust the center speaker output level when you select "PHANTOM" or "OFF" for the center mode.

6. Press TEST again to stop the test tone.



Remote Control

COMPU LINK Remote Control System

The COMPU LINK remote control system allows you to operate JVC audio components through the remote sensor on the receiver.

To use this remote control system, you need to connect JVC audio components through the COMPU LINK-3 (SYNCHRO) jacks (see below) in addition to the connections using cables with RCA pin plugs (see page 9).

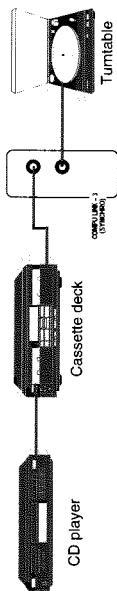

Notes:

- If your audio component has two COMPU LINK-3 (SYNCHRO) jacks, you can use either one. If it has only one COMPU LINK-3 (SYNCHRO) jack, connect it so that it is the last item in the series of components. (For example, the turntable or CD player in the diagram above.)
- Refer also to the manuals supplied with your audio components.

This remote control system allows you to use four functions listed below.

■ Remote Control through the Remote Sensor on the Receiver

You can control the connected audio components through the remote sensor on the receiver using this remote control. For details, see page 36.

Note:

Aim the remote control directly at the remote sensor on the receiver.

■ Automatic Source Selection

When you press the play (▶) button on a connected component or on its own remote control, the receiver automatically turns on and changes the source to the component. On the other hand, if you select a new source on the receiver or the remote control, the selected component begins playing immediately.

In both cases, the previously selected source continues playing without sound for a few seconds.

■ Automatic Power On/Off (Standby) (only possible with the COMPU LINK-3 connection)

Both the CD player and cassette deck turn on and off (into standby mode) along with the receiver. When you turn on the receiver, the CD player or cassette deck will turn on automatically, depending on which component has been previously selected.

When you turn off the receiver (into standby mode), both the CD player and cassette deck will turn off (into standby mode).

■ Synchronized Recording

Synchronized recording means the cassette deck starts recording as soon as a CD or a record begins playing.

To use synchronized recording, follow these steps:

- 1 Put a tape in the cassette deck, and a disc in the CD player (or a record on the turntable).
 - 2 Press the record (●) button and the pause (||) button on the cassette deck at the same time.
- This puts the cassette deck into recording pause.

Note:

If you do not press the record (●) button and pause (||) button at the same time, the synchronized recording feature will not operate.

3 Press the play (▶) button on the CD player or on the turntable.

The source changes on the receiver, and as soon as play starts, the cassette deck starts recording. When the play ends, the cassette deck enters recording pause, and stops about 4 seconds later.

Notes:

- During synchronized recording, the selected source cannot be changed.
- If your CD player is playing in program mode, a 4-second blank is recorded between tracks so that the music scan feature of your cassette deck can be used on the recorded tape.
- If the power of any component is shut off during synchronized recording, the COMPU LINK remote control system may not operate properly. In this case, you must start again from the beginning.

Using the Remote Control for Operating JVC Audio/Video Components

You can operate JVC's audio and video components with this receiver's remote control.

To operate these components with the remote control, first select a source with the source selecting buttons on the remote control. Then, operate that source using the remote control.

Note:

If you choose a source on the front panel, the remote control will not operate that source. To operate a source with the remote control, the source must be selected using buttons on the remote control.

IMPORTANT:

To operate JVC's audio components using this remote control:

- You need to connect JVC audio components through the COMPU LINK-3 (SYNCHRO) jacks (see page 35) in addition to the connections using cables with RCA pin plugs (see page 9).
- Aim the remote control directly at the remote sensor on the receiver.

After pressing FM/AM, you can perform the following operations:

FM/AM Alternates between FM and AM (MW/LW).

1 — 10, +10 Selects a preset channel number directly.

To select channel number 5, press 5. For channel number 15, press +10, then 5. For channel number 20, press +10, then 10.

After pressing CD, you can perform the following operations on a CD player:

▶ Starts playing.

◀ Returns to the beginning of the current (or previous) track.

◀▶ Skips to the beginning of the next track.

■ Stops playing.

■ Pauses. To release pause, press ▶.

1 — 10, +10 Selects a track number directly.

To select track number 5, press 5. For track number 15, press +10, then 5. For track number 20, press +10, then 10.

After pressing CD-DISC, you can perform the following operations on a CD player-changer:

1 — 6, 7/P

Select the number of a disc installed in a CD player-changer. Then continue to operate the CD player as described above.

After pressing TAPE, you can perform the following operations on a cassette deck:

▶ Starts playback.

▶ Fast winds a tape from right to left.

▶ Fast winds a tape from left to right.

■ Stops operation.

■ Pauses. To release pause, press ▶.

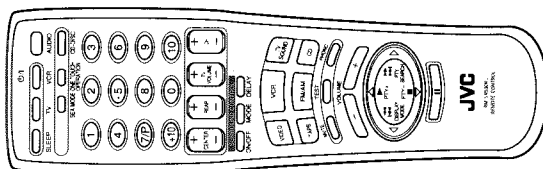

Troubleshooting

Use this chart to help you solve daily operational problems. If there is any problem you cannot solve, contact your JVC service center.

PROBLEM	POSSIBLE CAUSE	SOLUTION
The display does not light up.	The power cord is not plugged in or \odot POWER pressed to set it in the \blacksquare OFF position.	Plug the power cord into an AC outlet and/or press \odot POWER to set it in the \blacksquare ON position.
No sound from speakers.	Speaker signal cables are not connected.	Check speaker wiring and reconnect if necessary.
	The SPEAKERS 1 and 2 buttons are not set correctly.	Press SPEAKERS 1 and 2 correctly.
	An incorrect source is selected.	Select the correct source.
	Mute is activated.	Press MUTE to cancel the mute.
Sound from one speaker only.	Speaker signal cables are not connected properly.	Check speaker wiring and reconnect if necessary.
	The balance is set to one extreme.	Adjust the balance properly.
Continuous hiss or buzzing during FM reception.	Incoming signal is too weak.	Connect an outside FM antenna or contact your dealer.
	The station is too far away.	Select a new station.
	An incorrect antenna is used.	Check with your dealer to be sure you have a correct antenna.
	Antennas are not connected properly.	Check connections.
Occasional cracking noise during FM reception.	Ignition noise from automobiles.	Move the antenna further from automobile traffic.
Howling during record playing.	Your turntable is too close to speakers.	Move speakers away from the turntable.
Remote control does not work.	There is an obstruction in front of the remote sensor on the receiver.	Remove the obstruction.
	Batteries are weak.	Replace batteries.

IMPORTANT:

- To operate JVC's video components using this remote control:
- Aim the remote control directly at the remote sensor on the VCR or TV, not on the receiver.

After pressing VCR, you can perform the following operations on a VCR:

- Starts playback.
- Re winds a video tape.
- Fast winds a video tape.
- Stops operation.
- Pauses. To release pause, press \blacktriangleright .
- Changes TV channels on a VCR.
- Selects the channels on the VCR.

Note:

You can also turn the VCR on and off by pressing VCR \odot on the remote control.

After pressing TV SOUND, you can perform the following operations on TV:

- Changes TV channels.
- Selects the channels.
- +10 button will function as the ENTER button if your TV requires pressing the ENTER button after selecting a channel number.

Notes:

- You can always adjust the volume on the TV by pressing TV VOLUME +/- on the remote control.
- You can also turn the TV on and off by pressing TV \odot on the remote control.

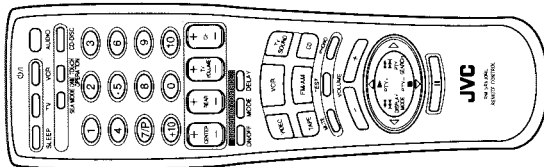

Specifications

Amplifier

Output Power	At Stereo operation Front Channels	80 watts per channel, min. RMS, both channels driven into 4 ohms at 1 kHz with no more than 0.9 % total harmonic distortion. (IEC268-3/DIN)
		70 watts per channel, min. RMS, both channels driven into 8 ohms at 1 kHz with no more than 0.9 % total harmonic distortion. (IEC268-3/DIN)
		65 watts per channel, min. RMS, both channels driven into 8 ohms, 40Hz to 20kHz with no more than 0.06 % total harmonic distortion.
	At Surround operation Front Channels	70 watts per channel, min. RMS, driven into 8 ohms at 1 kHz with no more than 0.7 % total harmonic distortion.
	Center channel	70 watts, min. RMS, driven into 8 ohms at 1 kHz, with no more than 0.7 % total harmonic distortion.
	Rear channels	70 watts per channel, min. RMS, driven into 8 ohms at 1 kHz, with no more than 0.7 % total harmonic distortion.
Total Harmonic Distortion (8 ohms, 1 kHz)		0.06 %* at 65 watts output (* Measured by JVC Audio Analysis System)
Audio Input Sensitivity/ Impedance (1 kHz)	PHONO (MM) CD, VCR, VIDEO, TV SOUND, TAPE	2.5 mV/47 k ohms 230 mV/47 k ohms
Audio Output Level	TAPE, VCR	230 mV
Signal-to-Noise Ratio (*66 IHF/DIN)	PHONO CD, VCR, VIDEO, TV SOUND, TAPE	70 dB/66 dB 87 dB/67 dB
Frequency Response (8 ohms) (Volume Control at -40 dB)	PHONO CD, VCR, VIDEO, TV SOUND, TAPE	20 Hz to 20 kHz (± 1 dB) 20 Hz to 20 kHz (± 1 dB)
RIAA Phono Equalization		± 0.5 dB (20 Hz to 20 kHz)
Loudness Control (Volume Control at -40 dB)		+6 dB ± 1 dB at 100 Hz +4 dB ± 1 dB at 10 kHz
S.E.A.	Center Frequencies Control Range	100 Hz, 1 kHz, 10 kHz ± 10 dB ± 2 dB

Video

Video Input Sensitivity/Impedance	VCR, VIDEO	1 V _{p-p} /75 ohms
Video Output Level	VCR, MONITOR OUT	1 V _{p-p} (at 1 V _{p-p} input)
Synchronization		Negative
Signal-to-Noise Ratio		45 dB

FM tuner (IHF)

Tuning Range	87.5 MHz to 108.0 MHz
Usable Sensitivity	10.8 dBf (0.95 μ V/75 ohms)
50 dB Quieting Sensitivity	16.3 dBf (1.8 μ V/75 ohms)
	38.3 dBf (22.5 μ V/75 ohms)
Signal-to-Noise Ratio (IHF-A weighted)	80 dB at 85 dBf
Total Harmonic Distortion	73 dB at 85 dBf
	0.15 % at 1 kHz
	0.2 % at 1 kHz
Stereo Separation at REC OUT	40 dB at 1 kHz
Capture Ratio	1.5 dB (10 mV)
Alternate Channel Selectivity	60 dB: (± 400 kHz)
Frequency Response	30 Hz to 15 kHz: (+0.5 dB, -3 dB)

AM (MW/LW) tuner

Tuning Range	MW: LW:	522 kHz to 1,629 kHz 144 kHz to 288 kHz
Usable Sensitivity	MW: Loop antenna External antenna LW: Loop antenna	300 μ V/m 30 μ V 600 μ V/m
Signal-to-Noise Ratio		50 dB (100 mV/m)

General

Power Requirements	AC 230V $\sqrt{}$, 50 Hz
Power Consumption	280 watts 2 watts (in standby mode)
Dimensions (W x H x D)	435 x 156.5 x 412 mm (17 $\frac{1}{16}$ x 6 $\frac{1}{16}$ x 16 $\frac{1}{4}$ inches)
Mass	10.3 kg (22.7 lbs)

Designs & specifications are subject to change without notice.

RX-630RBK

-MEMO-

■ MN101C01DAC1 (IC401) DECK & CD controller

1. Terminal Layout

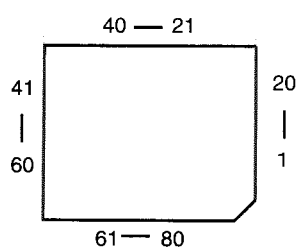

2. Description

Pin No.	Symbol	I/O	Function and Operation	Pin No.	Symbol	I/O	Function and Operation
1		--	Not use	41	VIDEOON/OFF	O	Video on/off control
2	VCRS/C	I	S-signal/Composite select input	42		--	
3		--	Not use	43		--	
4		--	Not use	44	VL/VH	O	RY882 control signal
5		--	Not use	45	SEADATA	O	Data signal for IC551
6		--	Not use	46	SEACLK	I	Clock signal for IC551
7		--	Not use	47	4/8ΩSELECT	I	4Ω/8Ω select switch input
8		--	Not use	48	4/8ΩSELECT	I	4Ω/8Ω select switch input
9		--	Not use	49			Not use
10		--	Not use	50	SURRSTB	O	Strobe signal for IC601
11	Vdd	--	Power Supply	51		--	Not use
12	OSC2	I/O	Osillation terminal	52	M/CS	O	Chip select to IC411
13	OSC1	I/O	Osillation terminal	53	MRESET	O	Micon reset signal output
14	Vss	--	Connected to GND	54	MDO	I	Communication data output for IC411
15	X1	--	Connected to GND	55	MDI	O	Communication data input from IC411
16	X0	--	Connected to GND	56	MCLK	O	Communication clock to IC411
17		--	Connected to GND	57		--	
18	DATA	O	Data signal for IC321	58	SVOLSTB	O	Strobe signal for IC307
19		--	Not use	59	FVOLSTB	O	Strobe signal for IC305
20	CLK	O	Clock signal for IC321	60	ASWSTB	O	Strobe signal for IC321
21	RDSRESET	O	Reset signal for LC7073	61	SMUTE	O	Source mute signal output
22	RDSDATA	I	Data signal from LC7073	62	CENT3	O	Center tone control
23	RDSCLK	I	Clock signal from LC7073	63	CENT2	O	Center tone control
24	SURON/OFF	O	Rec bias ON/OFF control	64	CENT1	O	Center tone control
25	RESET	I	Reset signal input	65	/TUN/MEMI	O	TUN/MEM indicator control
26	TCE	O	Chip select terminal outputl	66	/SEAADJ/MEMI	O	SEAADJ/MEM indicator control
27	TCK	O	Clock for PLL synthesizer	67	/SEAI	O	SEA indicator control
28	IFDATA	I	Data from PLL synthesizer	68	/SETI	O	SET indicator control
29	TDATA	O	Data for PLL synthesizer	69	/ADJI	O	Adjust indicator control
30	TMUTE	O	Tuner mute signal output	70	/SURI	O	Surround indicator control
31	TUNED	O	TUNED indication control	71		--	Not use
32	STEREO	O	Stereo indication control	72	TAPE/VCR	O	TAPE indicator control
33	RDSD-ST	O	Reset signal for IC191	73	/PHONOI	O	PHONO indicator control
34	MBUSY	O	Busy signal for IC411	74	/CDI	O	CD indicator control
35	/INHIN	I	Inhibit signal input	75	/AMI	O	AM indicator control
36	OSDATA	O	On screendata signal output	76	/FMI	O	FM indicator control
37	OSDSTB	I	On screen strobe signal	77	/TVSOUND	O	TVSOUND indicator control
38	OSDCLK	O	On screen clock signal	78	/VCR	O	VCR indicator control
39	VIDEO1	O	Video1 select signal output	79	/VIDEO2I	O	Vdeo2 indicator control
40	VIDEO2	O	Video2 select signal output	80	/VIDEO1I	O	Vdeo1 indicator control

■ MN17602 FL & System controller

1. Terminal Layout

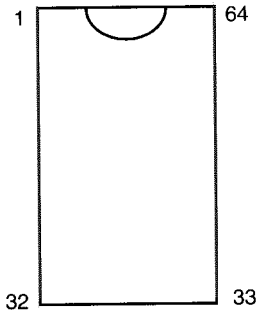

2. Key matrix

	KEY OUT0	KEY OUT1	KEY OUT2	KEY OUT3	KEY OUT4	KEY OUT5	KEY OUT6
KEY IN0			ADJUST		TUNER MEMORY		
KEY IN1		SEA MEMORY	↑	↓	TA/NES/ INFO		
KEY IN2	STOP	SURROUND	SOURCE	TUNER	PTY SELECT		
KEY IN3	E ON	SETTING	SEA		DISPLAY MODE		

3. Terminal Function

Pin No.	Symbol	I/O	Function	Pin No.	Symbol	I/O	Function
1	VDD	-	Power supply	33	15G	O	Grid control output
2	S16	O	Segment control signal	34	16G	O	Grid control output
3	S15	O	Segment control signal	35	17G	O	Grid control output
4	S14	O	Segment control signal	36	POWER	I	Power supply relay control
5	S13	O	Segment control signal	37	JOG2	I	Input 2 of JOG pulse
6	S12	O	Segment control signal	38	JOG1	I	Input 1 of JOG pulse
7	S11	O	Segment control signal	39	MBUSY	I	Busy signal from IC401
8	S10	O	Segment control signal	40	MCLK	I	Clock to IC401
9	S9	O	Segment control signal	41	MDI	I	Communication data from IC401
10	S8	O	Segment control signal	42	MDO	O	Communication data for IC401
11	S7	O	Segment control signal	43	MRESET	I	Reset signal input
12	S6	O	Segment control signal	44	M/CS	I	Chip select RX-630R/RX-730R
13	S5	O	Segment control signal	45	RMI	I	Remote signal input
14	S4	O	Segment control signal	46	VCRI	I	VCR compulink signal input
15	S3	O	Segment control signal	47	DCSIN	I	Compulink signal input
16	S2	O	Segment control signal	48	DCS OUT	O	Compulink signal output
17	S1	O	Segment control signal	49	VCRO	O	VCR compulink signal output
18	Vpp	-	Power supply(-B)	50	TVO	O	AV compulink signal output
19	1G/KO0	O	Grid control output/Key matrix output	51	TVC	O	AV compulink signal output
20	2G/KO1	O	Grid control output/Key matrix output	52		-	Not use
21	3G/KO2	O	Grid control output/Key matrix output	53	STANDBYI	O	STANDBY indication control
22	4G/KO3	O	Grid control output/Key matrix output	54		-	Not use
23	5G/KO4	O	Grid control output/Key matrix output	55	ONEI	O	ONE indication control
24	6G	O	Grid control output	56	KI3	O	Key matrix output
25	7G	O	Grid control output	57	KI2	O	Key matrix output
26	8G	O	Grid control output	58	KI1	O	Key matrix output
27	9G/KO5	O	Grid control output/matrix output	59	KI0	O	Key matrix output
28	10G/KO6	O	Grid control output/matrix output	60	X1	I/O	Connected to GND
29	11G	O	Grid control output	61	X2	I/O	Not use
30	12G	O	Grid control output	62	VSS		Connected to GND
31	13G	O	Grid control output	3	OSC2	O	Osillation terminal
32	14G	O	Grid control output	64	OSC1	O	Osillation terminal

■ LC7218 (IC121): PLL Synthesizer

1. The main function descriptions

- (1)It makes the local oscillation frequency by the control data from IC401.
- (2)Decode the control signal and transmit the signal for receiving conditions.
- (3)For the best tuning, count the internal-frequency and transmit the data to IC401.

2. Terminal Layout

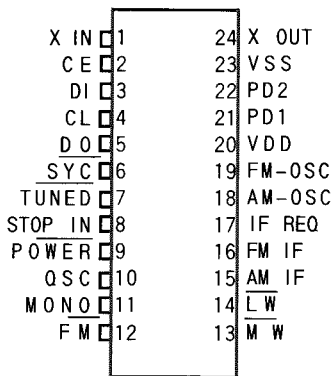

3. Block Diagram

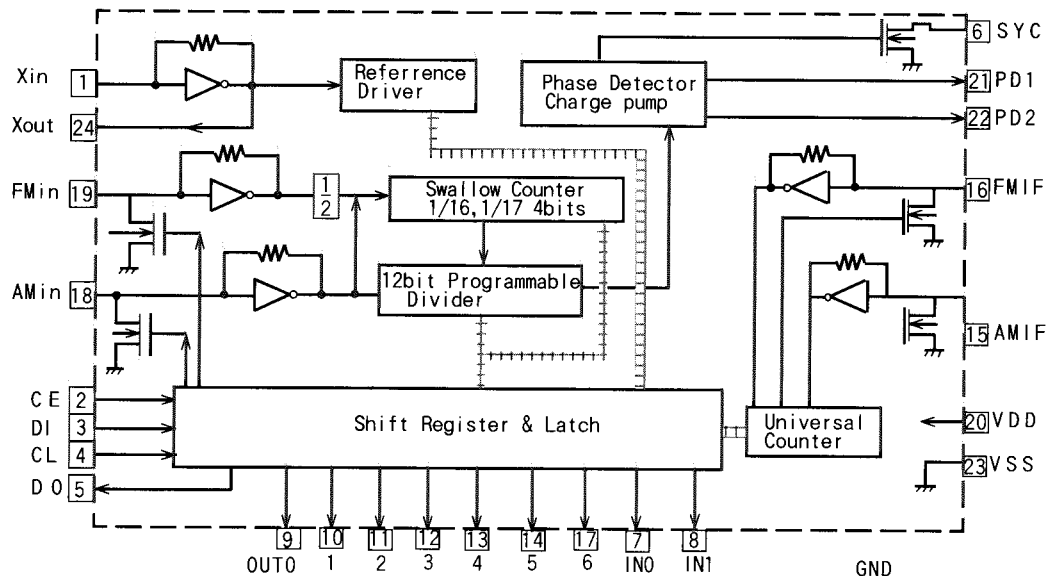

4. Pin Function Description

Pin No	Symbol	I/O	Functions and Operations
1,24	Xin,Xout	I/O	Crystal oscillator(7.2MHz)
2	CE	I	Fix the chip enable to 'H'when inputting(DI)and outputting(DO)the serial data.
3	DI	I	Receive the control data from the controller(IC401).
4	CL	I	This clock is used to synchronize data when transmitting the data of and DO.
5	DO	O	Transmit the data from LC7218JM to the controller which is synchronizedwith CL
6	SYC	-	Not used.
7	TUND	I	Receive the tuned signal from IC104(LA1266A)
8	STOP in	-	Connected to GND
9	POWER	-	Not used.
10	QSC	-	Not used.
11	MONO	O	It is 'H' on FM-Monaural,'L'on FM-Stereo.
12	FM	O	It is 'L'on MW mode.
13	MW	O	It is 'L'on LW mode.
14	LW	O	It is 'L'on FM mode.
15	AM-IF	I	Universal counter input for AM-IF from IC104(LA1266A).
16	FM-IF	I	Universal counter input for AM-IF from IC104(LA1266A).
17	AM adj	O	Output the 'IF-signal request' to IC104when the pin-7(tuned in)goes to'H'.
18	AM SOC	I	Input the local oscillator signal of AM.
19	AM-OSC	I	Input the local oscillator signal of AM.
20	Vdd	-	This is a terminal of power supply.
21	PD1	O	PLL charge pump output:When the local oscillator signal frequency is higher than the refer- ence frequency high level signals will output. When it is lower than the reference frequency,low level signals will output. When it is same as reference frequency signals,it will be floating.
22	PD2	-	Not used.
23	Vss	-	Connected to GND

■ LA3401 (IC105): FM MPX Detector

1. The main function descriptions

- (1) Detect the FM Multiplex Signal (Stereo signal).
- (2) When receiving FM Stereo Signal, it outputs the signal for indicator.
- (3) AM / FM Audio Amplifier.

2. Terminal Layout

AM in	1	22	Vcc
FM in	2	21	VCO
Pilot	3	20	LPF
Sepa	4	19	LPF
L out	5	18	Pilot in
L in	6	17	LPF
R in	7	16	LPF
R out	8	15	Mute in
mute	9	14	Mute Cont
FM/AM	10	13	STEREO
Mute out	11	12	GND

3. Block Diagram

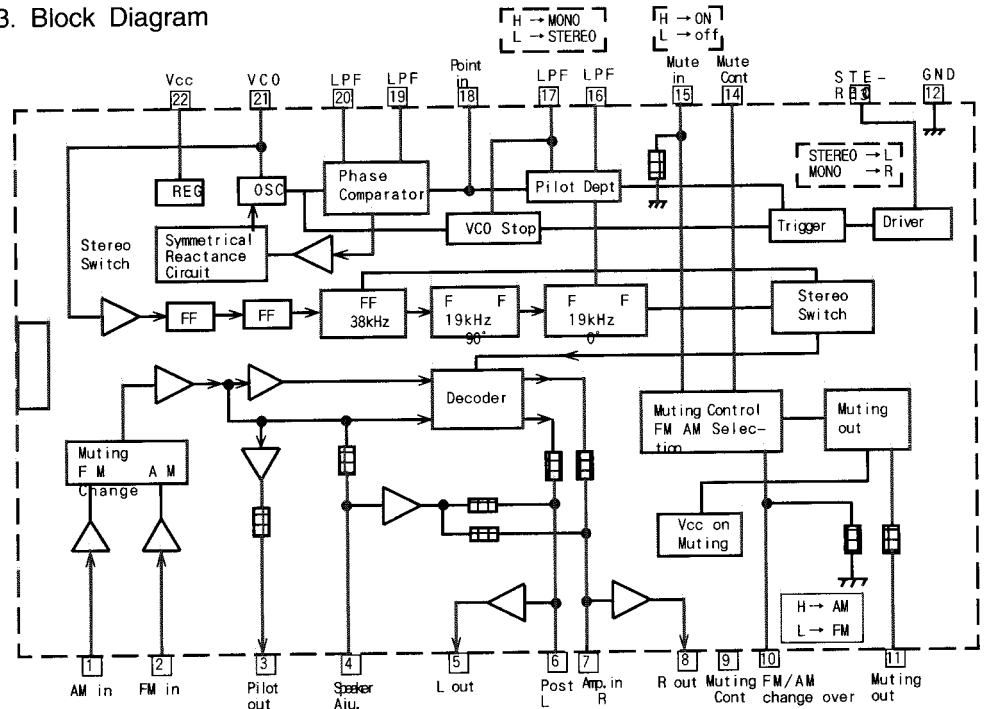

4. Pin Function Description

Pin No.	Symbol	I/O	Functions and Operations
1	AM in	I	This is an input terminal for AM detection signal.
2	FM in	I	This is an input terminal for FM detection signal.
3	Pilot out	O	Output of MPX pilot signal (Connect to Pin18).
4	Speaker Aju.	-	Separation adjustment.
5	L out	O	Left channel signal output.
6	L	O	Reversal output of pin5.
7	R	O	Reversal output of pin8.
8	R out	O	Right channel signal output
9	Muting Cont	-	The mute time is controlled by the connected capacitor when tuning the power switch ON
10	FM/AM	I	Changer over the FM/AM input. 'H': AM, 'L' : FM.
11	Mute out	-	Not use.
12	GND	-	Ground terminal.
13	Stereo	O	Stereo indicator output.Stereo:'L',Mono :'H'
14	Mute out	-	The mute time is controlled by the connected capacitor when changing over the FM/AM
15	Mute in	I	Mute signal input. 'H': Mute on, 'L' : Mute
16	LPF	-	Low pass filter of pilot detector
17	LPF	-	While this terminal goes to 'H',the VCO stop.
18	Pilot in	I	Pilot input.
19	LPF	-	Low-pass filter of PLL
20	LPF	-	Low-pass filter of PLL
21	VCO	I	Voltage controlled oscillator terminal.
22	Vcc	-	Power supply

■ LA1266A (IC104): FM AM IF AMP & Detector

1. The main function descriptions

- (1) Amplify and detect of FM intermodulation frequencies.
- (2) It has local oscillator and mixer for AM, and amplify the AM-IF signal.

2. Terminal Layout

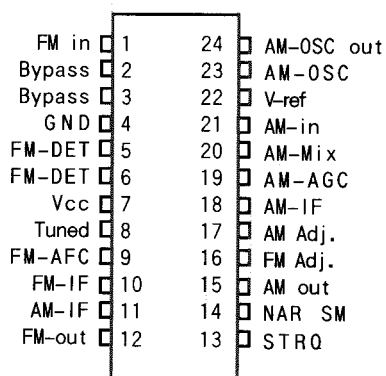

3. Block Diagram

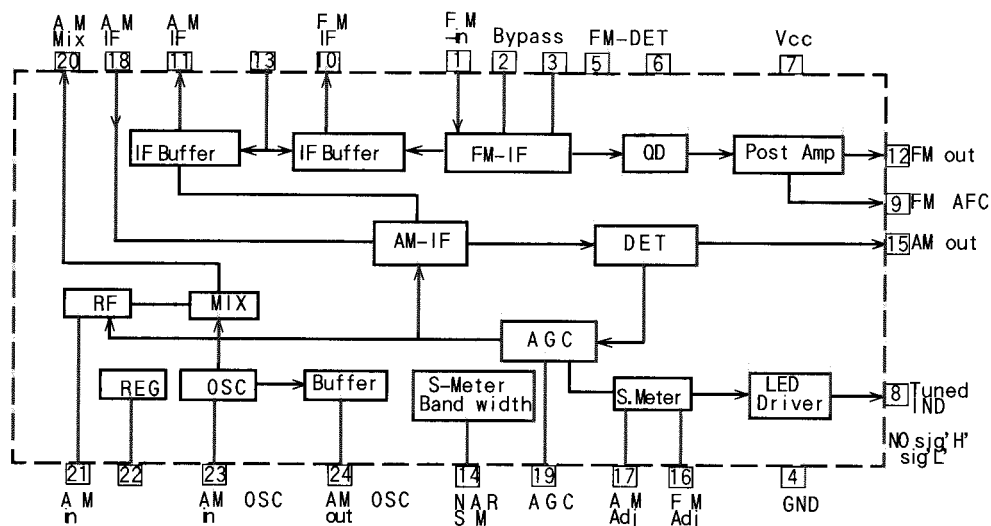

4. Pin Function Description

Pin No	Symbol	I/O	Functions and Operations
1	FM in	I	This is an input terminal of FM signal.
2,3	Bypass		Bypass of FM IF Amp.
4	GND	-	This is the device ground terminal.
5,6	FM DET	-	FM detect transformer.
7	Vcc	-	This is power supply terminal.
8	Tuned	O	When the set is tuning, this terminal become 'L'.
9	FM AFC	O	This is output terminal of voltage for FM-AFC.
10	FM IF out	O	When the IF REQ signal of IC102(LC7218) applies to pin 13, the signal of FM IF outputs.
11	AM IF out	O	When the IF REQ signal of IC102(LC7218) applies to pin 13, the signal of AM IF outputs.
12	FM out	O	FM detection output.
13	STRQ	I	The IF-signals come out from pin10(FM-IF) or pin11(AM-IF) while this terminal goes to 'High'.
14	NAR SM	-	Control the Band-width of AM signal meter.
15	AM out	O	AM detection output.
16	FM adj	-	For adjust the stop level(or mute level) of FM.
17	AM adj	-	For adjust the stop level(or mute level) of AM.
18	AM-IF	I	Input of AM IF signal .
19	AM-AGC	I	This is AGC voltage Input terminal for AM.
20	AM-MIX	O	This is an output terminal for AM mixer
21	AM-IN	I	This is an input terminal for AM RF Signal.
22	V.REF	-	Control the Band-width of FM signal meter.
23	AM-OSC	-	This is a terminal of AM Local oscillation circuit.
24	AM-OSC out	O	

■ SAA6579(IC192) Radio data system demodulator

1. Terminal Layout

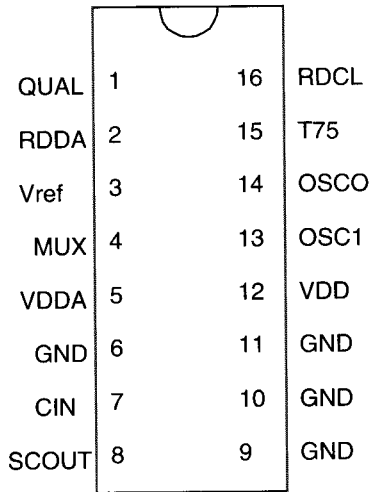

2. Pin Function

Pin No	Symbol	I/O	Function
1	QUAL	--	Non connection
2	RDDA	O	RDS data output
3	Vref	O	Reference voltage output
4	MUX	I	Multiplex signal input
5	VDDA	--	+5Vsupply voltage for analog
6	GND	--	Ground for analog part(0V)
7	CIN	I	Subcarrier outputof reconstruction filter
8	SCOUT	O	Ground for digital part(0V)
9	GND	--	Ground for digital part(0V)
10	GND	--	Ground for digital part(0V)
11	GND	--	Ground for digital part(0V)
12	VDD	--	+5Vsupply voltage fordigital part
13	OSC1	I	Oscilator input
14	OSCO	O	Oscilator OUTput
15	T57	--	Non connection
16	RDCL	O	RDS clock output

3. Block Diagram

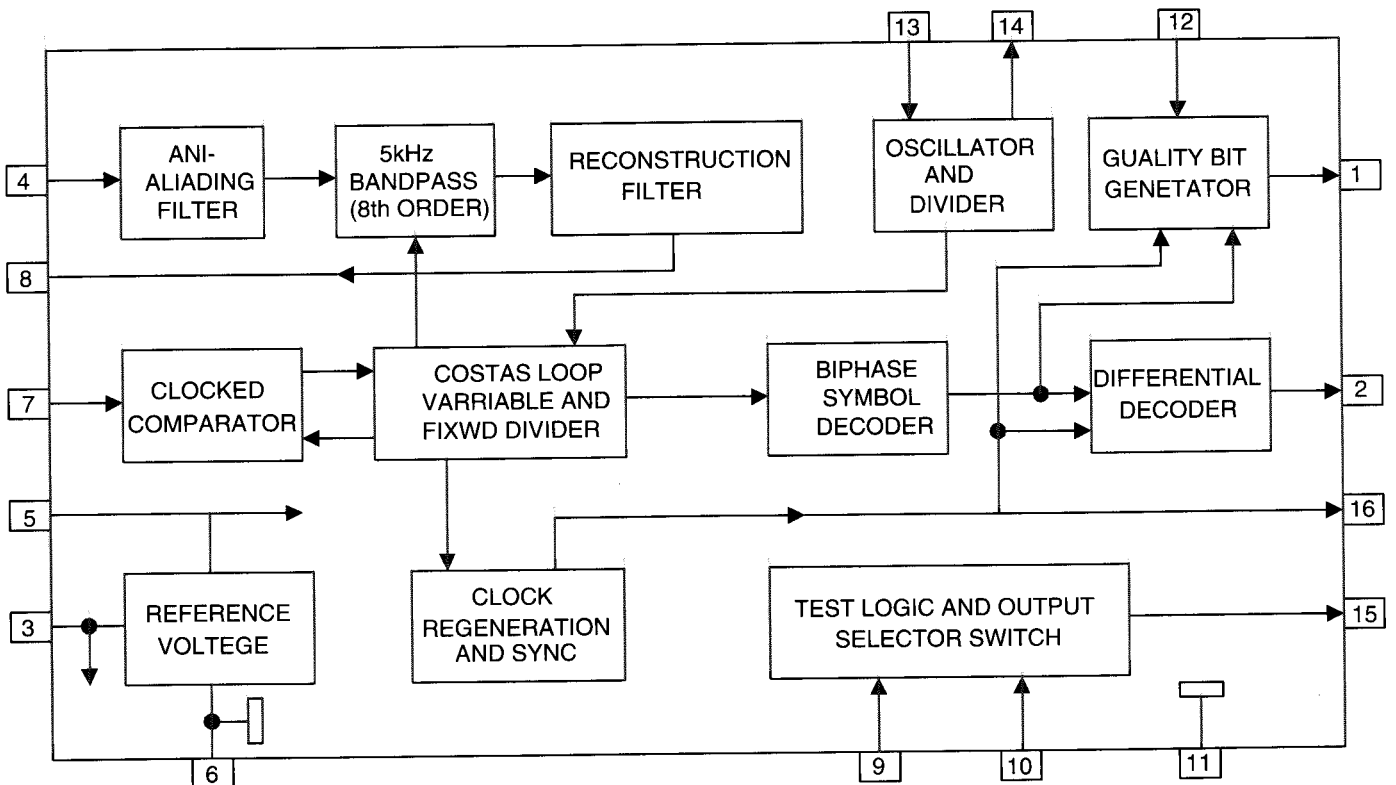

■ LC7073M(IC191):Radio Data System

1.Terminal Layout

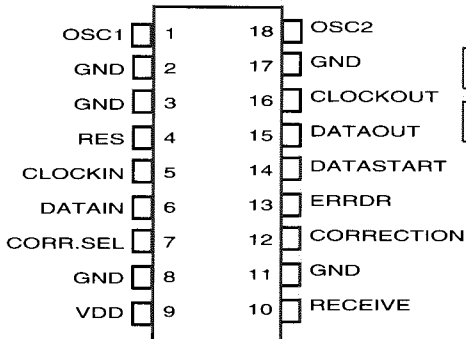

2.Block Diagram

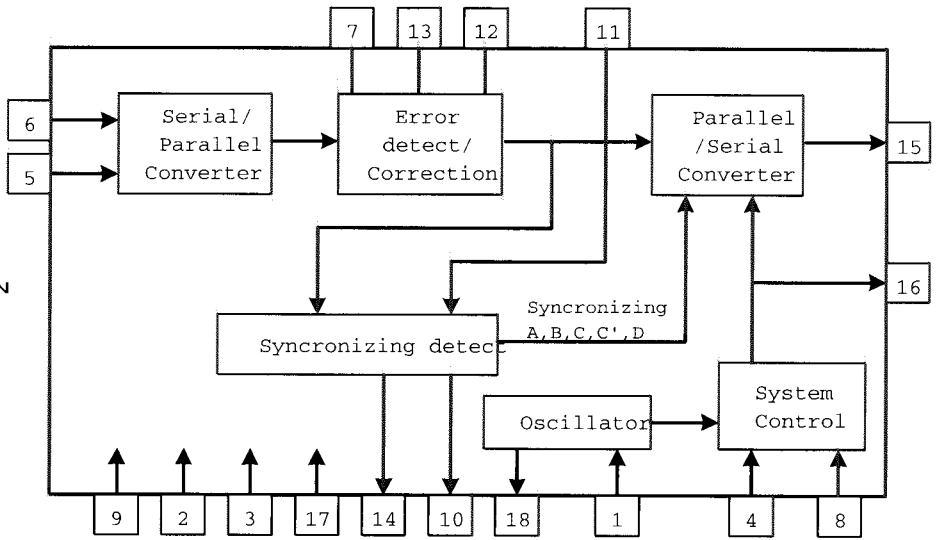

3.Pin Function

Pin No.	Symbol	I/O	Function	Pin No.	Symbol	I/O	Function
1	OSC1	I	Oscillation	10	RECEIVE	--	Non connection
2	GND	--	GND	11	GND	--	GND
3	GND	--	GND	12	CORRECTION	--	Non connection
4	RES	I	Reset input	13	ERRDR	--	Non connection
5	CLOCK IN	I	RDS clock input	14	DATA START	O	Data start signal for block data to output serial data
6	DATA IN	I	RDS data input	15	DATA OUT	O	Serial data output
7	CORR.SEL	I	Non connection	16	CLOCK OUT	O	Data output of serial data output
8	GND	I	GND	17	GND	--	GND
9	VDD	--	Power supply	18	OSC2	O	Oscillation terminal

■ TA7317P(IC901) : Protector

1.Terminal Layout

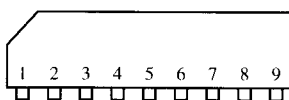

2.Block Diagram

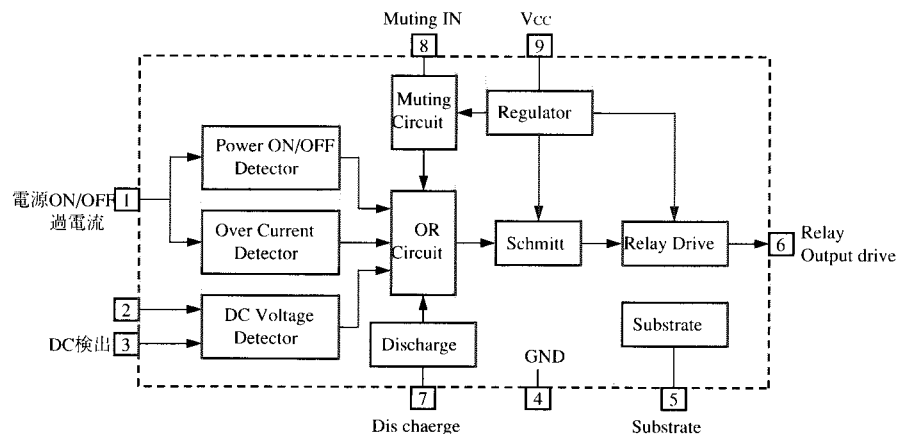

RX-630RBK

■ LV1016(IC641):Dolby Surround Passive Decoder

1. Terminal Layout

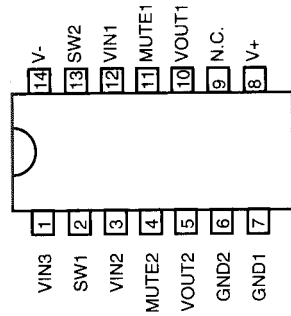

2. Block Diagram

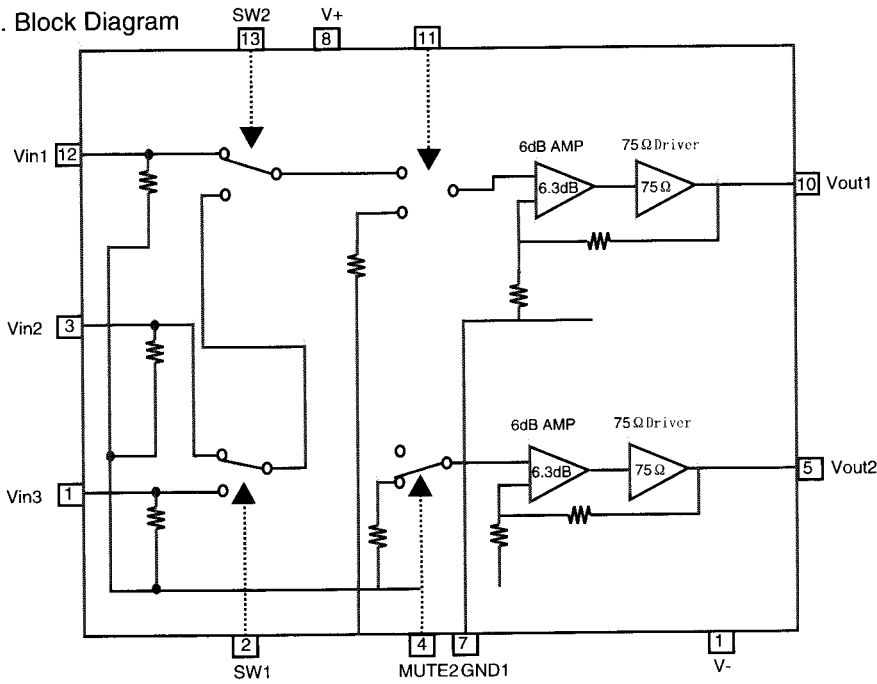

■ NJM2279D(IC221):Video Switch

1. Terminal Layout

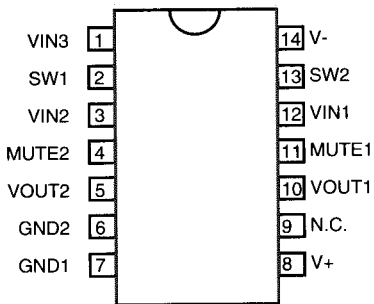

2. Block Diagram

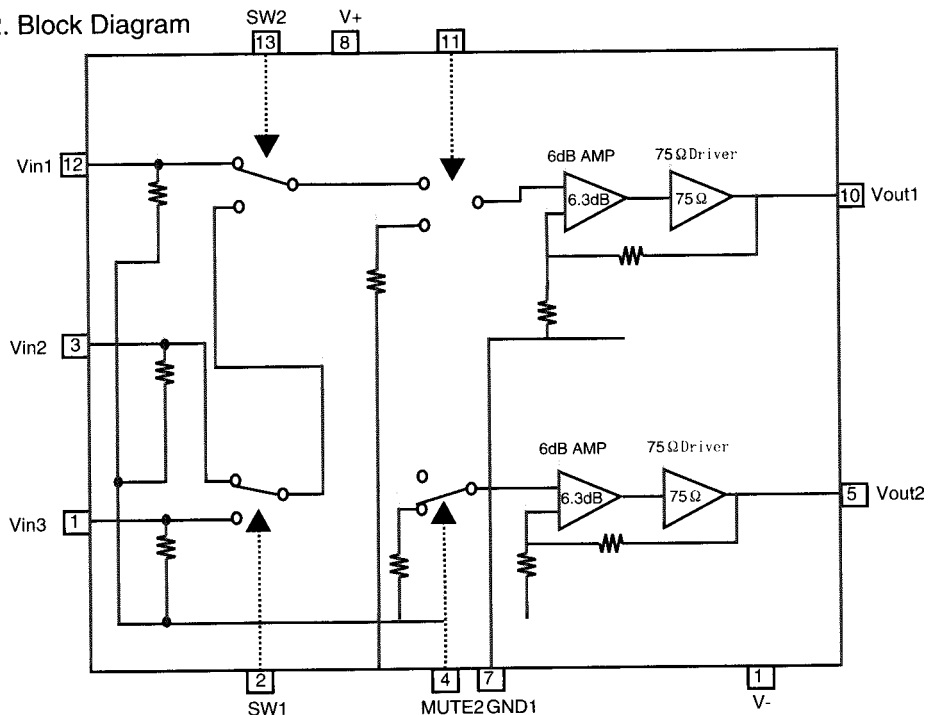

■ LA2786(IC601):Dolby Pro Logic Surround Signal Processor

1. Terminal Layout

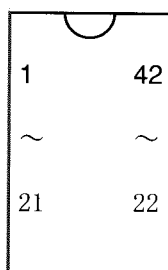

2. Pin Functions

Pin No	Symbol	I/O	Function	Pin No	Symbol	I/O	Function
1	NS-BPF1	--	Capacitor for spectrum in noise sequencer	22	VCS-1	--	Capacitor for time constant (in log defferential area)
2	NS-BPF2	--	Capacitor for spectrum in noise sequencer	23	VCS-2	--	Capacitor for time constant (in log defferential area)
3	VREF	--	Analog reference voltage	24	VCS-TH	--	Capacitor for time constant (in log defferential area)
4	S-DC-OUT	--	Capacitor for DC-cut Sch	25	L+R RECT	--	Capacitor for Center Channel detection
5	C-DC-OUT	--	Capacitor for DC-cut Cch	26	DC-CUT	--	Capacitor for DC-cut at detection circuit
6	L-DC-OUT	--	Capacitor for DC-cut Lch	27	L-R RECT	--	Capacitor for Surround channel detection
7	R-DC-OUT	--	Capacitor for DC-cut Rch	28	DC-CUT	--	Capacitor for DC-cut at detection circuit
8	VREF BUFFER	--	VREF low impedance	29	R-BPF3	--	LPF,HPF for Lch Right channel control circuit
9	L-IN	I	Left channel signal input	30	R-BPF2	--	LPF,HPF for Lch Right channel control circuit
10	R-IN	I	Ground	31	R-BPF1	--	LPF,HPF for Lch Right channel control circuit
11	GND	--	LPF,HPF for Lch control	32	C-TRIM DC-CUT	--	Capacitor for DC-cut Center Channel
12	L-BPF1	--	LPF,HPF Left channel control circuit	33	C-MODECAP8	--	Capacitor for Center Channel output low pass filter
13	L-BPF2	--	LPF,HPF Left channel control circuit	34	C-OUT	O	Center signal output
14	L-BPF3	--	LPF,HPF Left channel detection	35	S-OUT	O	Surround signal output
15	DC-CUT	--	Capacitor for DC-cut at detection circuit	36	R-OUT	O	Right channel signal output
16	R RECT	--	Capacitor Right channel detection	37	L-OUT	O	Left channel signal output
17	DC-CUT	--	Capacitor for DC-cut at detection circuit	38	Vcc	--	Power supply
18	L RECT	--	Capacitor for Left channel detection	39	OSC	--	Oscillation for noise sequencer and auto balance
19	VLR-TH	--	Capacitor for time constant (in log differential area)	40	STB	I	Strobe signal input
20	VLR-2	--	Capacitor for time constant (in log defferential area)	41	DATA	I	Serial interface data input
21	VLR-1	--	Capacitor for time constant (in log defferential area)	42	CLK	I	Serial interface clock

RX-630RBK

■ LC7522 (IC551) : Variable Resistor for SEA Control

1. Terminal Layout

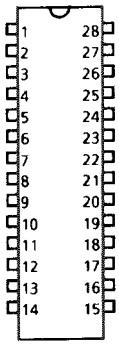

2. Block Diagram

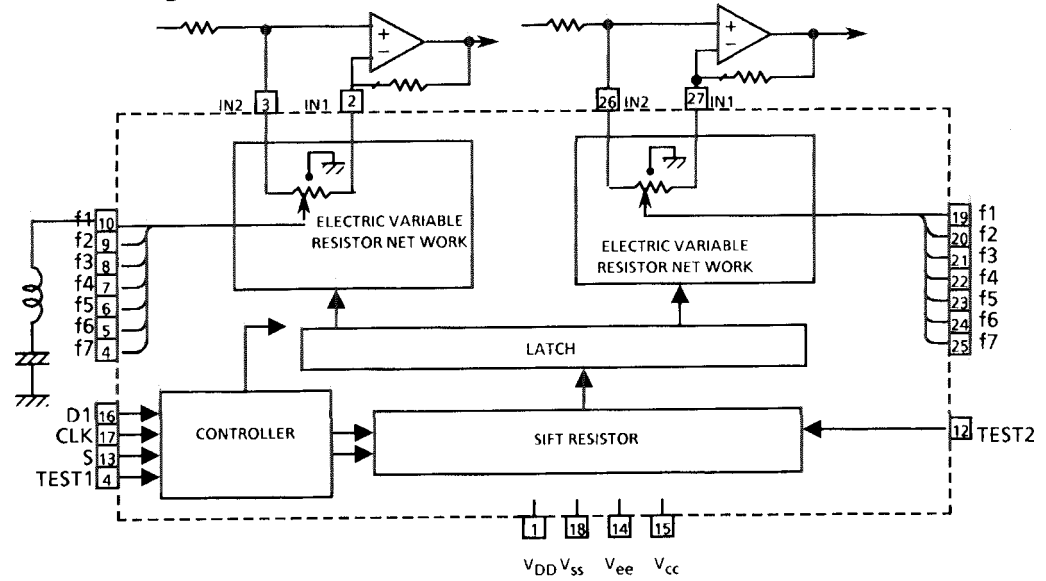

3. Pin Functions

Pin No.	Pin Name	Functions
1	V _{DD}	Power supply +7V for audio signal
18	V _{SS}	Ground.
14	V _{EE}	Power supply -7V for audio signal.
15	V _{CC}	Power supply +5V
2, 27	IN 1	Audio signal input
3, 26	IN 2	The inversion signal of the operational amplifier inputs to IN 1 normally. The non-inversion signal of the operational amplifier inputs to IN 2 normally.
16	DI	Data input from the CPU. Schmitt inverter type
17	CLK	Clock signal input from the CPU. Schmitt inverter type
4~10 19~25	f1~f7	For connect to band-pass filter. f1~f7x2 (Left and Right)
11	TEST 1	Not use
12	TEST 2	Not use
13	S	Chip Select
28	NC	Not use

■ M5243P (IC552) : S.E.A. Graphic Equalizer

1. Functions

It makes inductive characteristic instead of coil.

2. Block Diagram

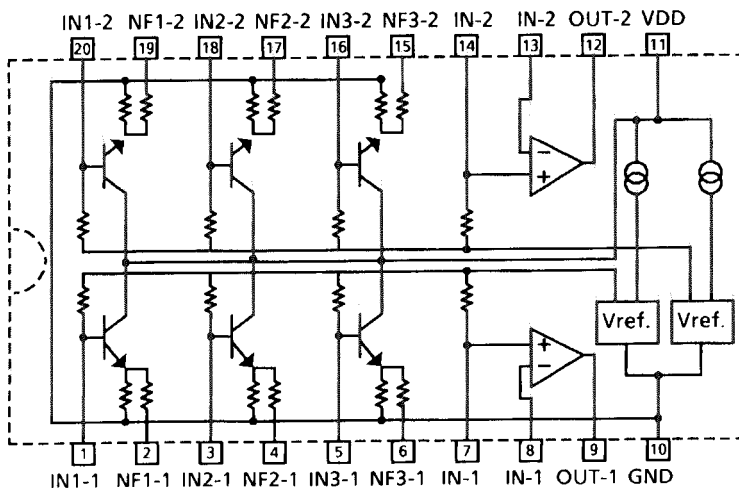

■ IC673 : M35012-120SP (ON SCREEN IC)

(1) Terminal Layout

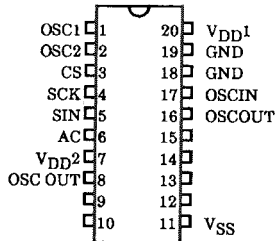

(2) Block Diagram

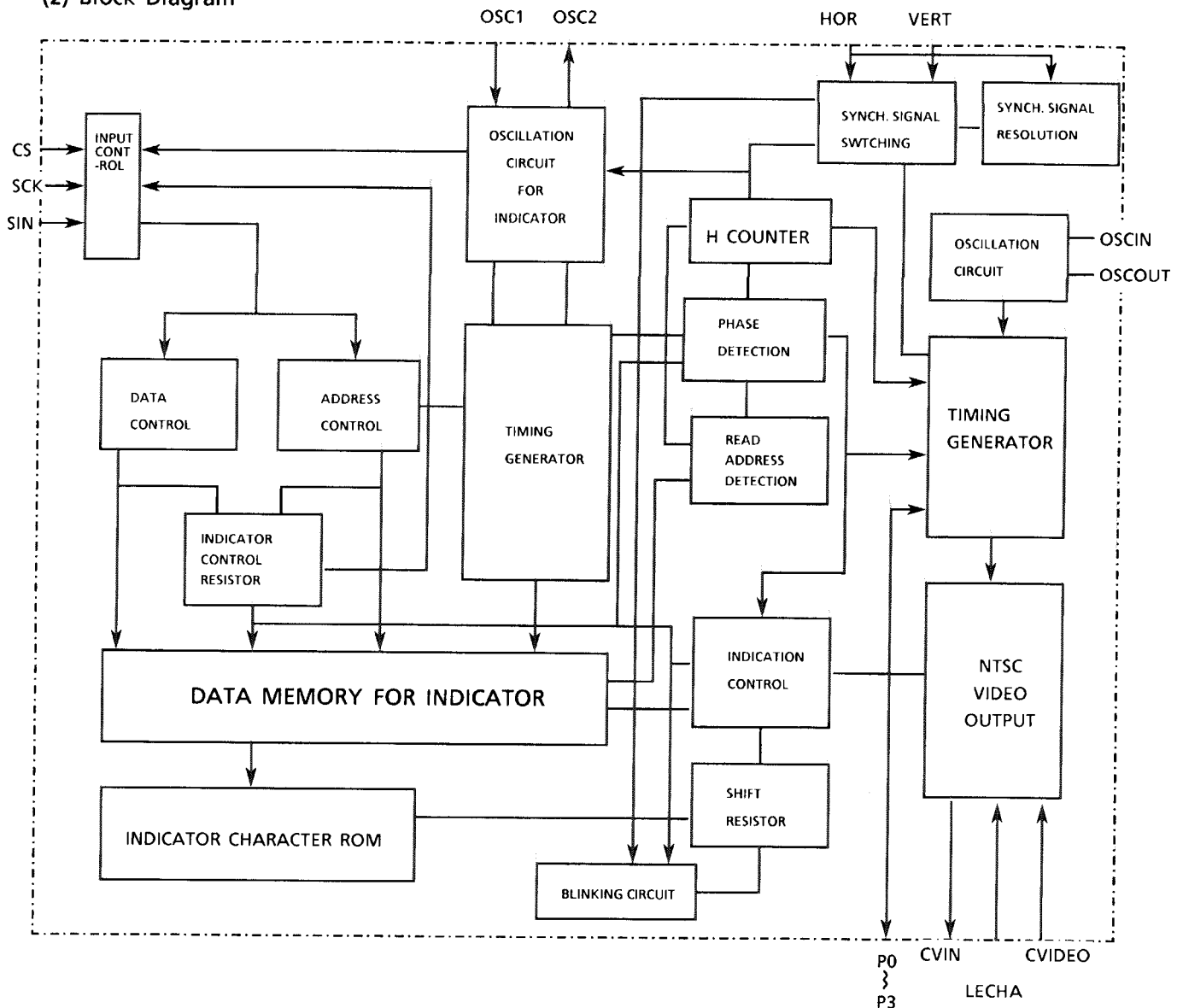

RX-630RBK

■ NJM2279D (IC221) : Video Switch

1. Terminal Layout

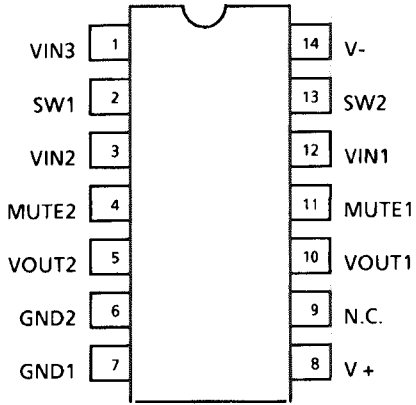

2. Block Diagram

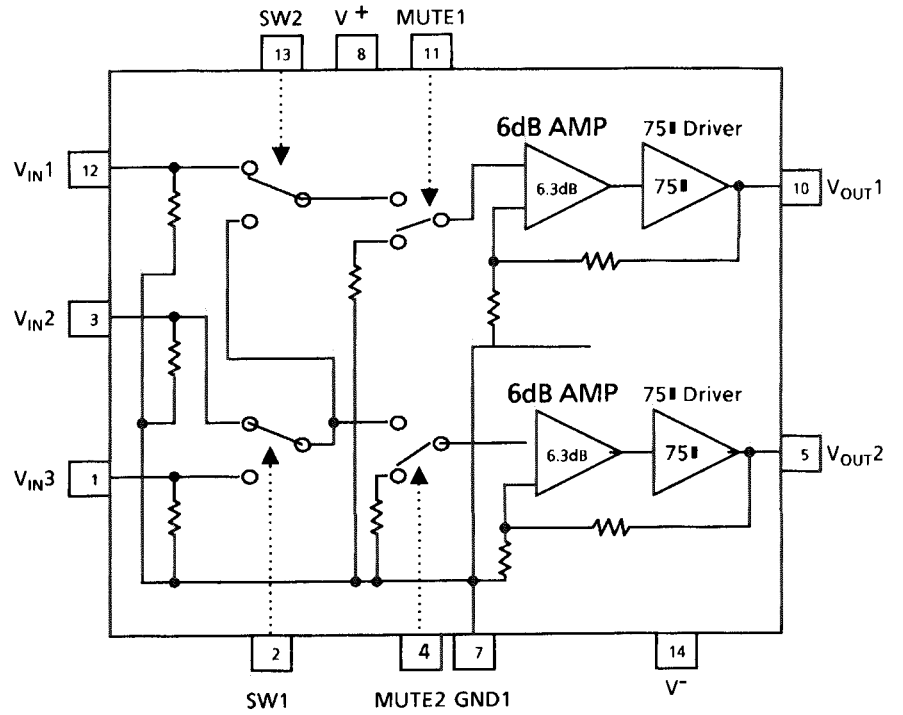

■ PST600E (IC403) : Reset IC

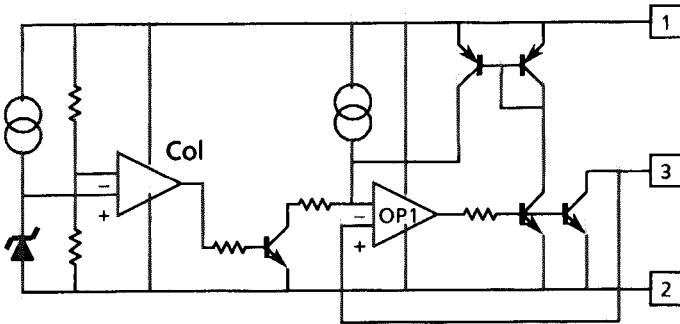

Internal Connection of the FL Display

ELU0001-215 (DI400)

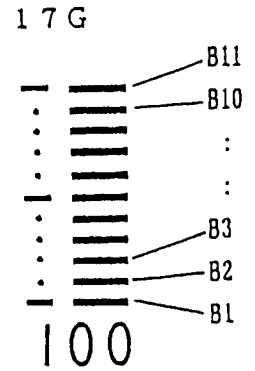
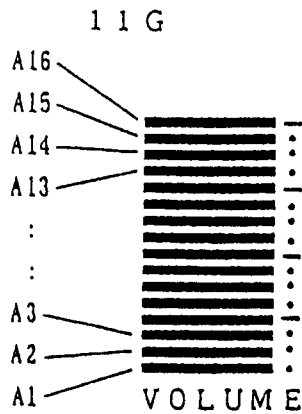
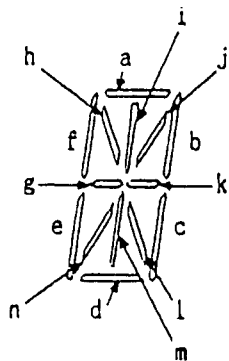
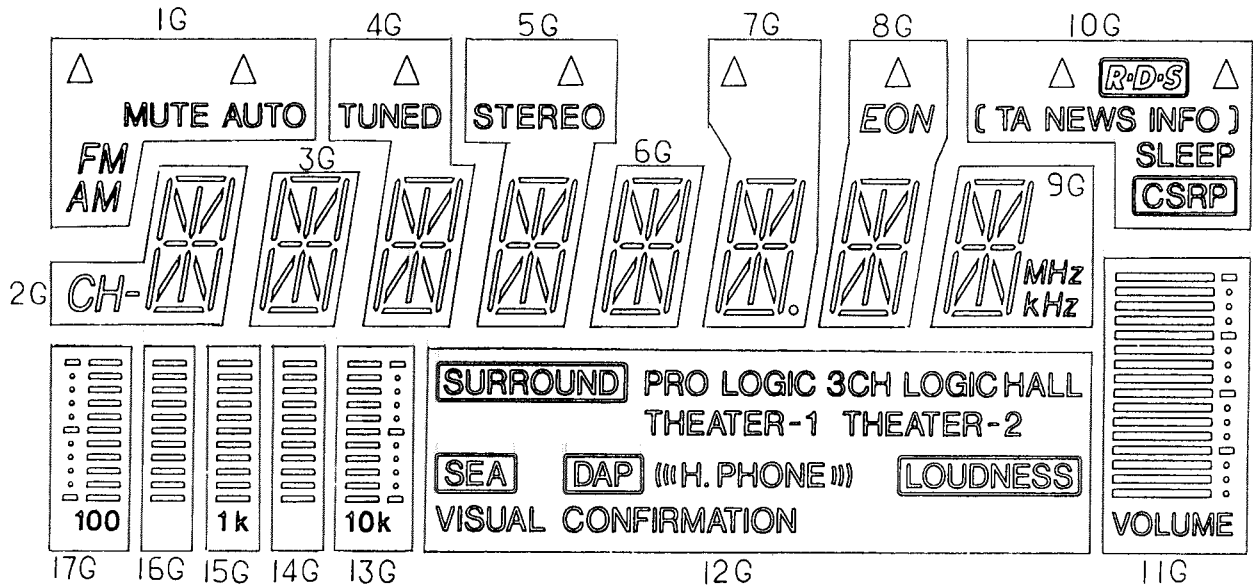

Pin Connection

TERMINAL NO.	1	2	3	4	5	6	7	8	9	10	11	12	13	14							
ELECTRODE	F1	F1	F1	NP	17G	16G	15G	14G	13G	12G	11G	10G	9G	8G							
TERMINAL NO.	15	16	17	18	19	20	21	22	23	24	25	26	27	28	29	30	31	32	33	34	
ELECTRODE	7G	6G	5G	4G	3G	2G	1G	NP	NP	NP	NP	NP	NP	P S1	P S2	P S3	P S4	P S5	P S6	P S7	
TERMINAL NO.									35	36	37	38	39	40	41	42	43	44	45	46	47
ELECTRODE									P S8	P S9	P S10	P S11	P S12	P S13	P S14	P S15	P S16	NP	F2	F2	F2

Notes F: Filament NP: No Pin
G: Grid
P: Anode

Main parts Layout

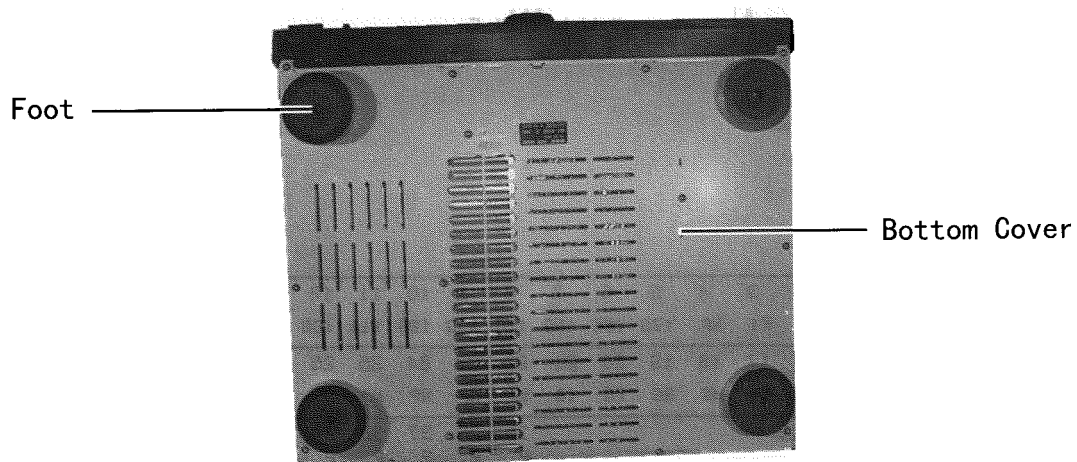
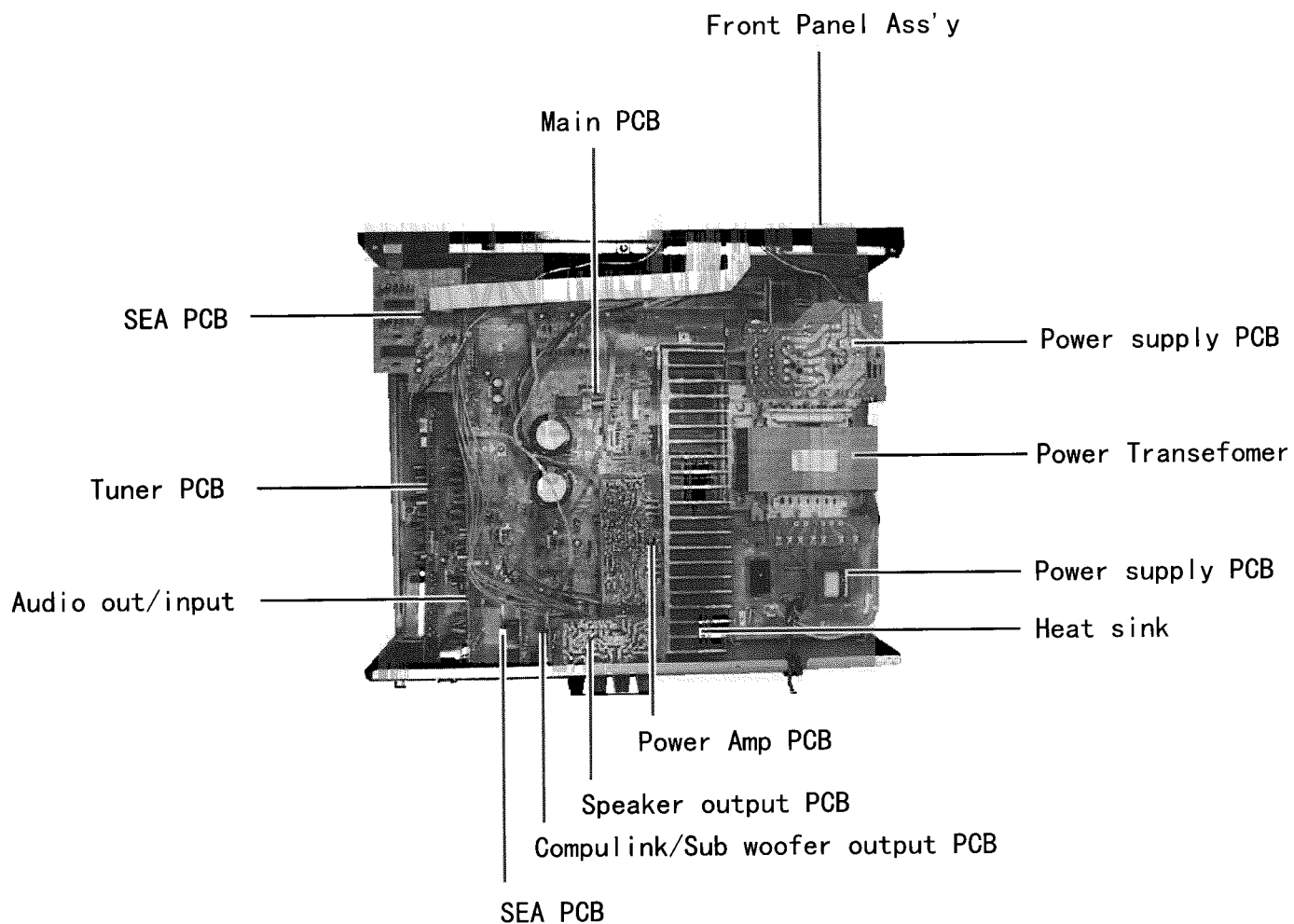

Disassembly Procedures

1. Top cover removal

- 1) Remove the 4 screws 'A' fasing the both side.
- 2) Remove the 3 screws 'B' fasing the rear side.
- 3) Remove the top cover

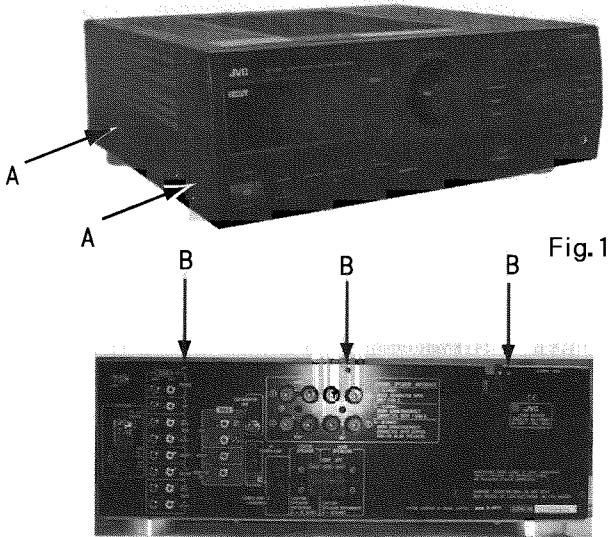

Fig.1

2. Rear panel removal

Fig.2

- 1) Remove the top cover.
- 2) Remove the 3 screws 'C' fasing the bottom side.
- 3) Remove the 18 screws 'B' fasing the rear side.
- 4) Remove the rear panel

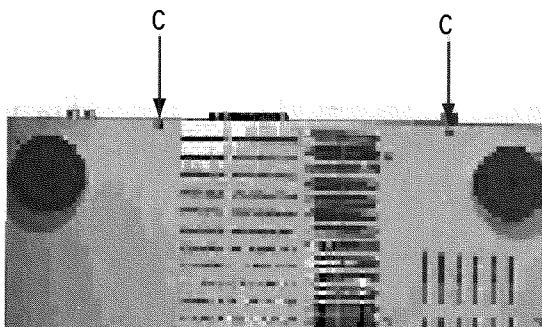

Fig.3

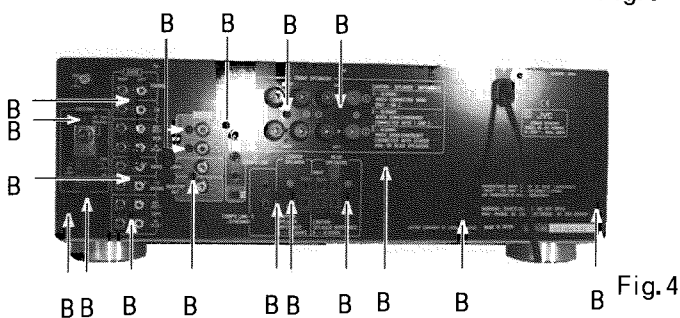

Fig.4

3. Front panel Ass'y removal

- 1) Remove the top cover.
- 2) Pull up the main volume knob, and remove the Nut.
- 3) Remove the 3 screws 'C' fasing the top side.
- 4) Remove the 4 screws 'B' fasing the bottom side.
- 5) Remove the Front panel Ass'Y.

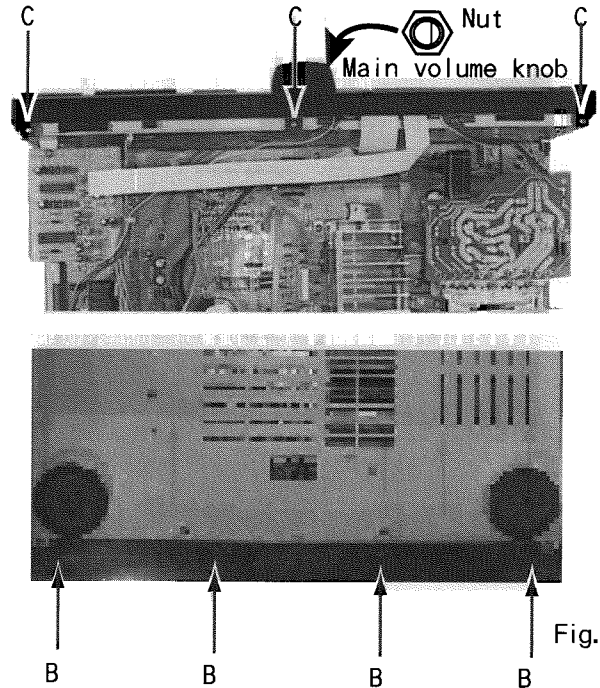

Fig.5

4. Tuner PCB removal

- 1) Remove the top cover.
- 2) Remove the Rear panel.
- 3) Disconnect the Soket wire from the CN112.
- 4) Remove the Tuner PCB.

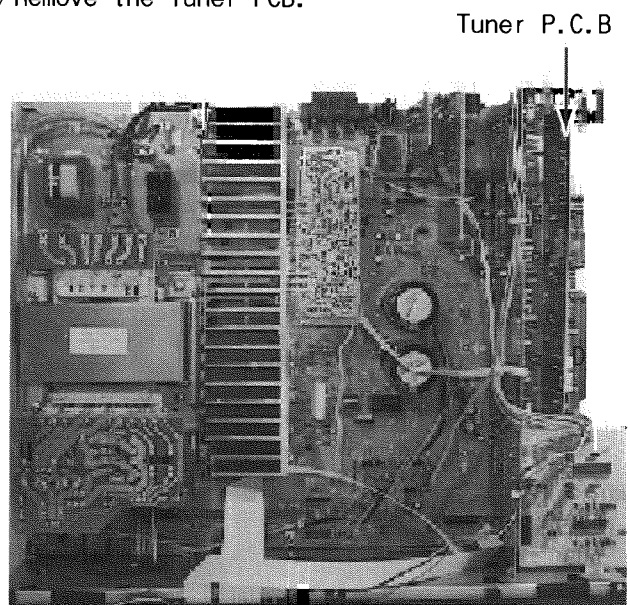

Fig.6

5. Bottom cover removal

- 1) Remove the top cover.
- 2) Remove the 11 screws 'B' and 2 screws 'E' fasing the bottom cover.
- 3) Remove the Bottom cover

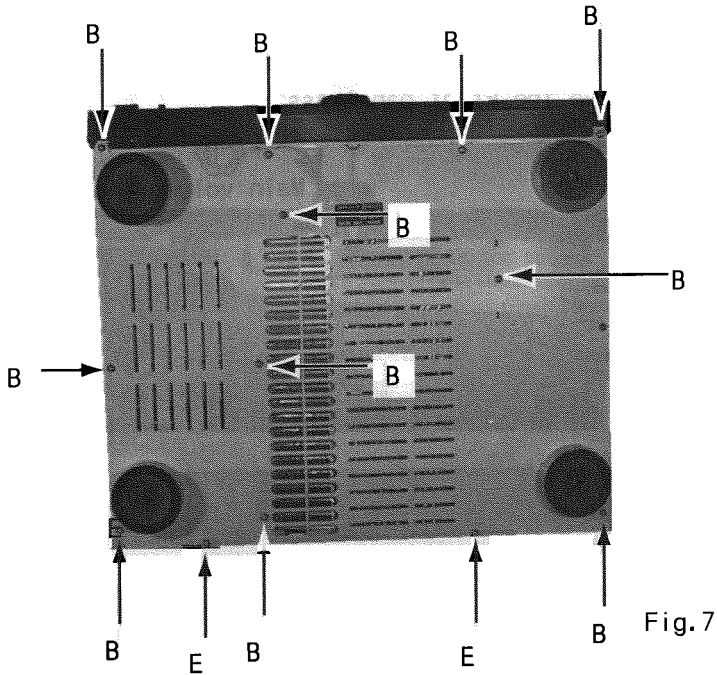

Fig.7

7. Main PCB and Heat sink removal

- 1) Remove the top cover and rear panel.
- 2) Remove the DSP/Tuner/Audio source/Video/ Compulink PCB.
- 3) Disconnect the CN311,CN812 and CN411.
- 4) Remove the Nut fasing the Headphone terminal.
- 5) Remove the 7 screws 'F' and 3 screws 'C'.
- 6) Remove Main PCB with the heat sink..

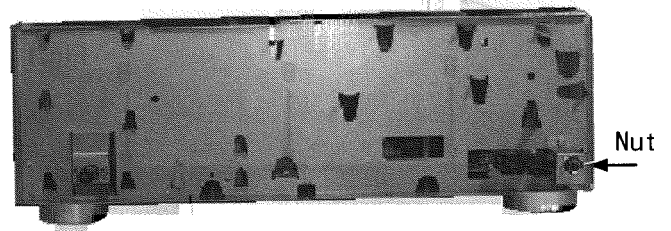

Fig.9

6. DSP/TUNER/AUDEO/VIDEO PCB removal

- 1) Remove the top cover and rear panel.
- 2) Remove the screw 'B' and disconnect the DSP PCB from the CN603.
- 3) Disconnect the CN112 and CN101, and Remove the tuner PCB.
- 4) Disconnect the CN312 and CN602, and Remove the AUDIO source PCB.
- 5) Disconnect the CN311 and CN 501, and Remove the video PCB.
- 6) Disconnect the CN701 and Remove the Compulink PCB.

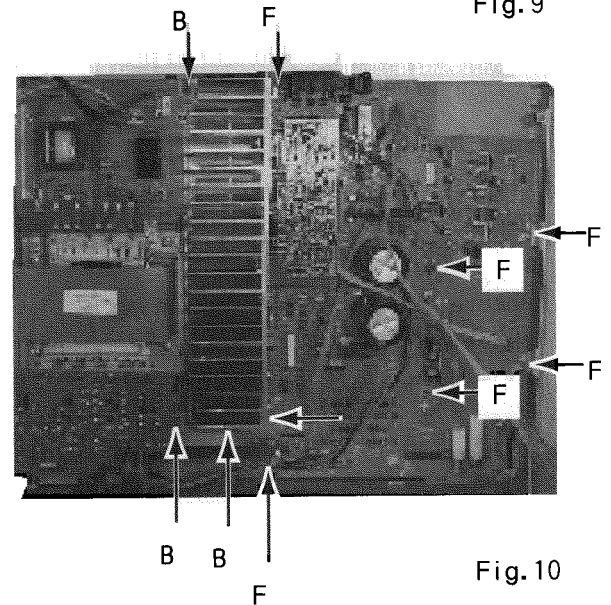

Fig.10

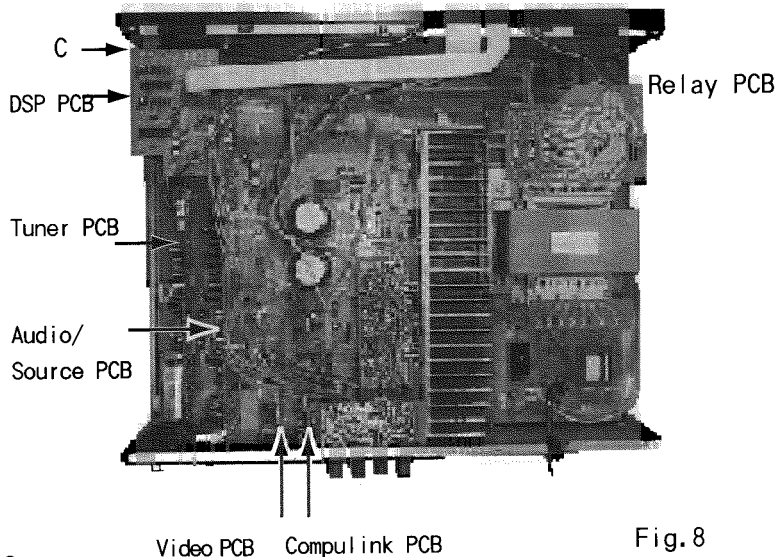
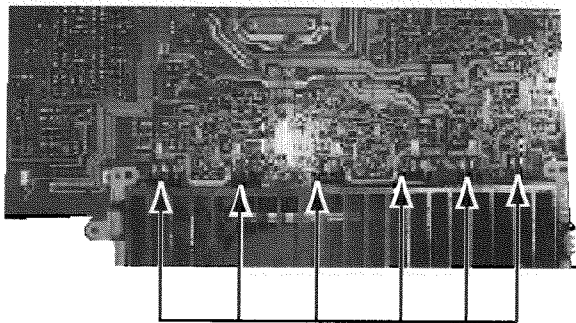

Fig.8

8. Power IC removal

- 1) Remove the top cover and rear panel.
- 2) Remove the DSP/Tuner/Audio source/Video/Compulink PCB.
- 3) Remove the bottom cover.
- 4) Unsolder the power IC terminal.
- 5) Remove the screws 'G'.
- 6) Remove the Power IC .



Power IC terminal

Fig.11



G

G G G

Fig.12

9. Power transeformer removal

- 1) Remove the top cover.
- 2) Unsolder the power transformer terminal.
- 3) Remove the 4 Screws 'H'.
- 4) Remove the transeformer.

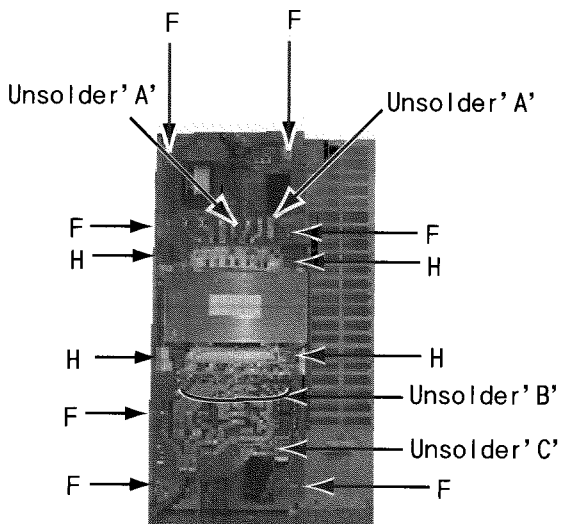

Fig.13

10. 1st Power PCB removal

- 1) Remove the top cover.
- 2) Disconnect the J003 and CN804.
- 3) Remove the 4 screws 'F'.
- 4) Unsolder the power transeformer terminal'A'.
- 5) Remove 1st Power PCB.

11. 2nd Power PCB removal

- 1) Remove the top cover.
- 2) Disconnect the CN413 and CN803,CN805.
- 3) Remove the 3 screws 'F'.
- 4) Unsolder the fraticable terminal'C'.
- 5) Remove 2nd Power PCB.

12. Front PCB removal

- 1) Remove the Front panel.
- 2) Remove the 10 Screws 'I'.
- 3) Remove the Front PCB.

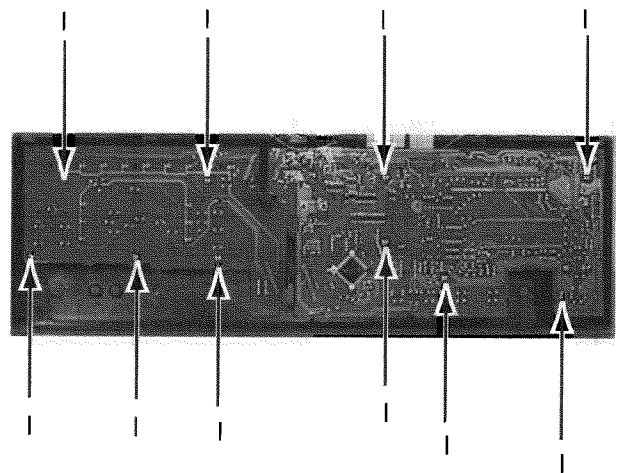
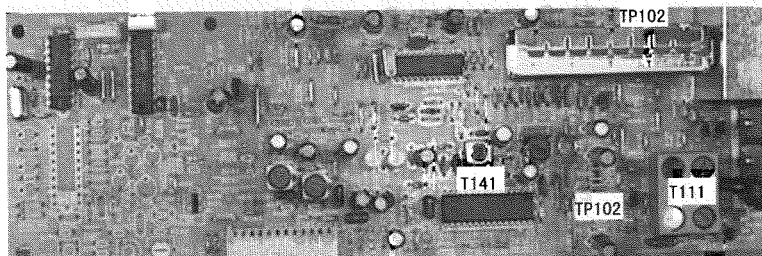

Fig.14

ADJUSTMENT PROCEDURES

■ Tuner section

Tuning point and test point



Tuner P. C. Board

(1) Tuning voltage

Confirm the voltages at TP101(VCC)B131,(GND)B132 is within the standard values shown in the table below.

Tuning range & Tuning voltage

Area	Range				
	LW (kHz)	MW (kHz)	FM (kHz)	FM TU. VOL	
				87.5MHz	108.0MHz
A, the U. K. , Europe	144~288	522~1629	87.5~108.0	1.6±1.0	8.0±2.0
Universal type (AM Channel space 9kHz)	-	531~1602	87.5~108.0	1.6±1.0	8.0±2.0
Universal type (AM Channel space 10kHz)	-	530~1600	87.5~108.0	1.6±1.0	8.0±2.0
Easern Europe	144~288	522~1629	65.0~74.0 87.5~108.0	65.0MHz >1.3	108.0MHz <11

AM Tuning voltage

Area	Frequency (MW)							Frequency (LW)	
	522kHz	530kHz	531kHz	1600kHz	1602kHz	1629kHz	1710kHz	144kHz	288kHz
A, the U. K. , Europe	>0.7	-	-	-	-	<8.3	-	0.5<1.0	5.0<7.5
Universal (Channel space 9kHz)	-	-	>0.8	-	<7.9	-	-	-	-
Universal (Channel space 10kHz)	-	>0.8	-	<7.9	-	-	-	-	-

(2) FM center meter

Receive a broadcast by using the function of 'AUTO STOP'.
Adjust T141 (detector coil) so the voltage at TP102 becomes 0 ± 1.5 mV.

■ AMP section

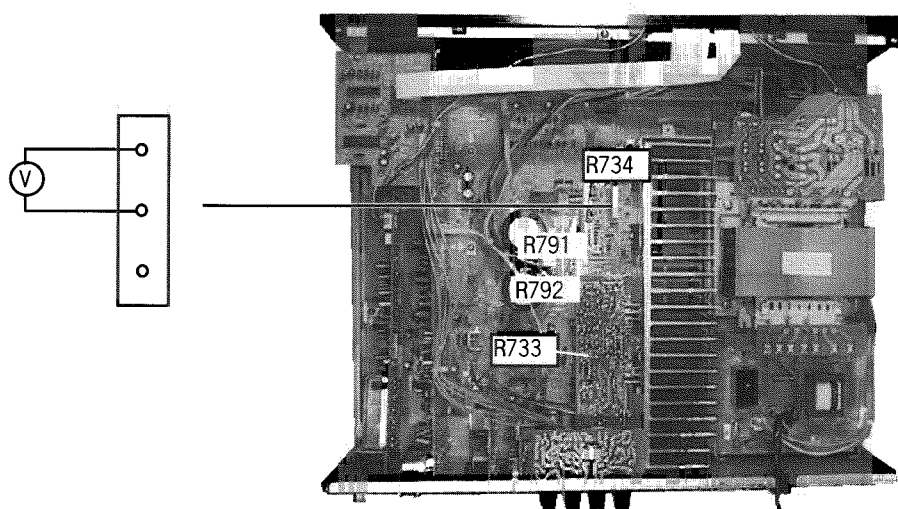

■ Idling current

- (1) Set the volume control to minimum during this adjustment. And set surround mode 'OFF'.
- (2) Turn VR791 and VR792 fully counterclockwise to warm up before adjustment.
If the heatsink is already warm from previous use the correct adjustment can not be made.
- (3) Connect a DC voltmeter to R773 resistors leads of left channel ,or to R774 for right channel.
- (4) Adjust R773 for left channel, or R774 for right channel, so that the DC voltmeter becomes 1mV - 10mV.

■ Block Diagram

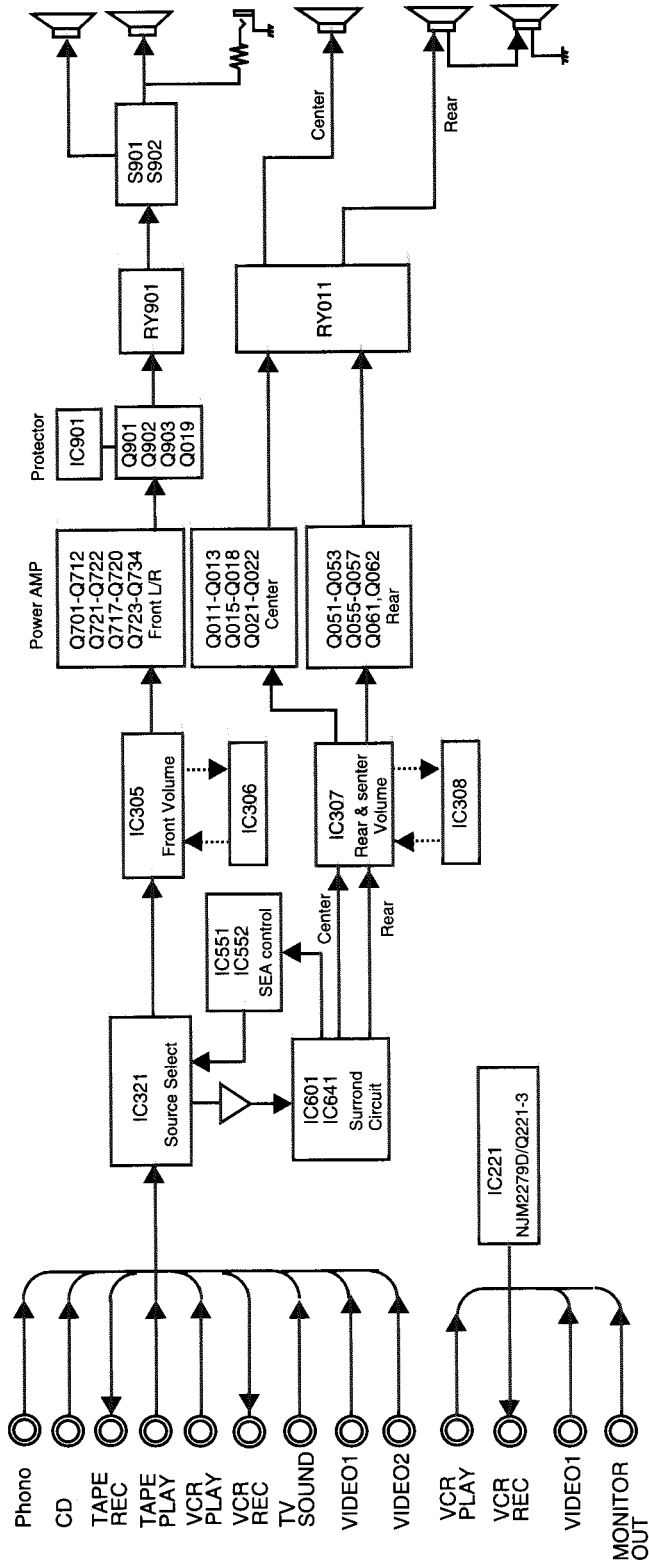

■ Control Section

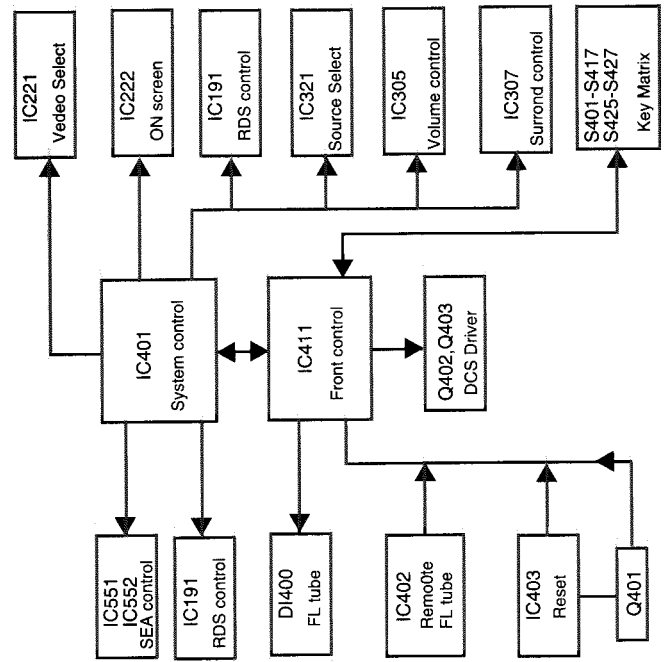

■ Power Supply Section

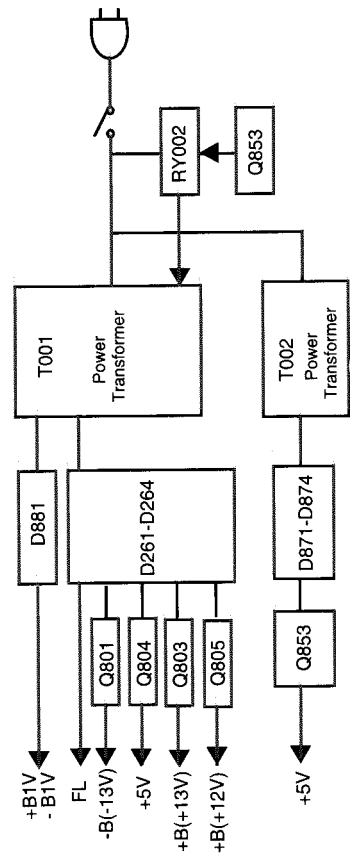

Schematic diagram

■ Power supply section

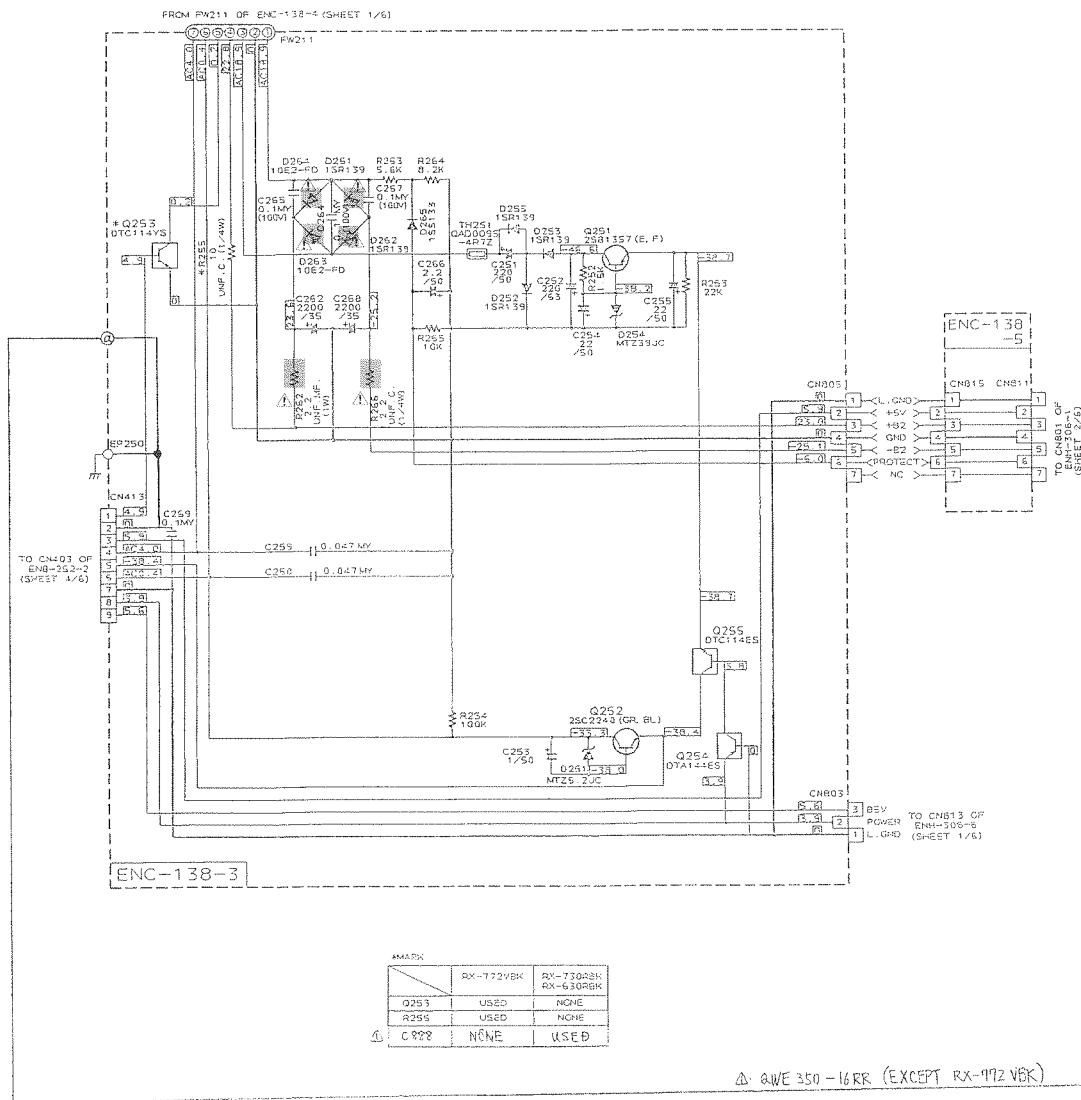

NOTE

- ➔ indicates main signal path.
- ➡ indicates video signal path.
- When replacing the parts in the darkended are (■) and those marked with ▲, be sure to use the designated parts to ensure safety.
- This is the standard circuit diagram the design and contents are subject to change without notice.

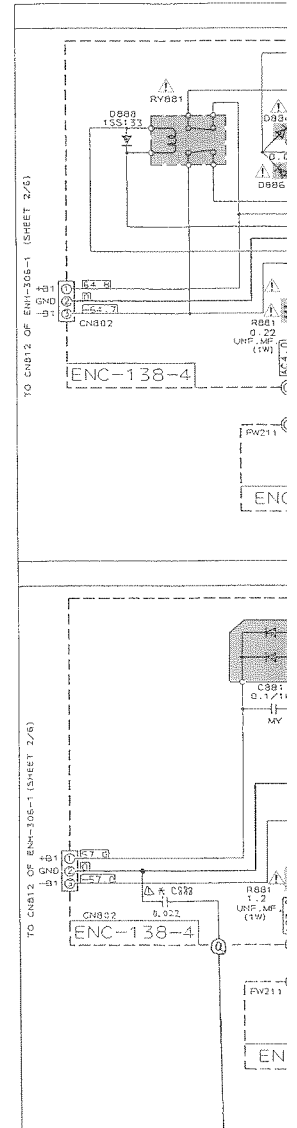

A

B

C

D

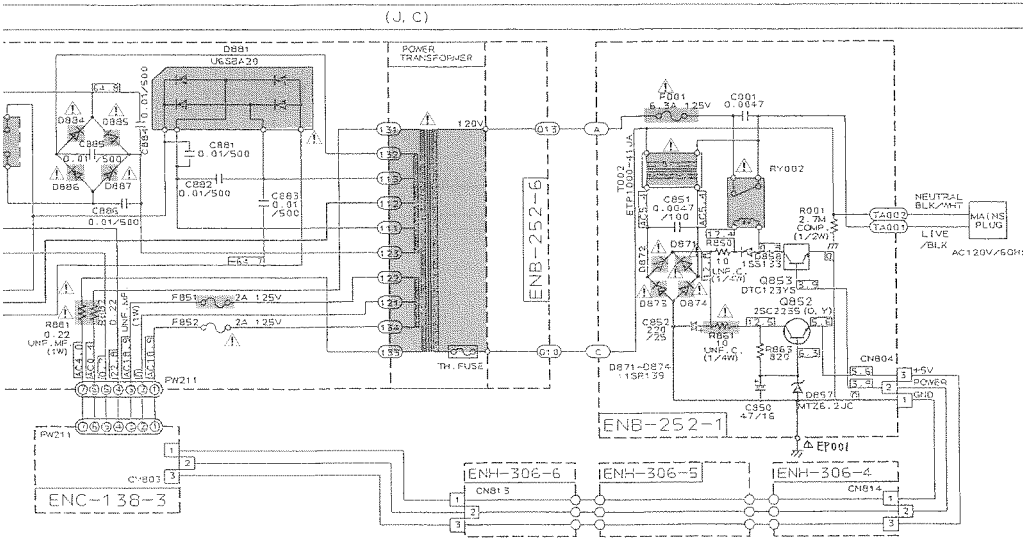

VERSION CODES
 J: U.S.A.
 C: CANADA
 EN: NORDIC COUNTRIES
 EF: CONTINENTAL EUROPE EXCEPT GERMANY AND ITALY
 G: GERMANY
 BS: U.K.

NOTE:
 1. MARK (*) IS TO SHOW DEVIATION IN VERSIONS. DETAILS ARE EXPLAINED NEAR THE MARK.

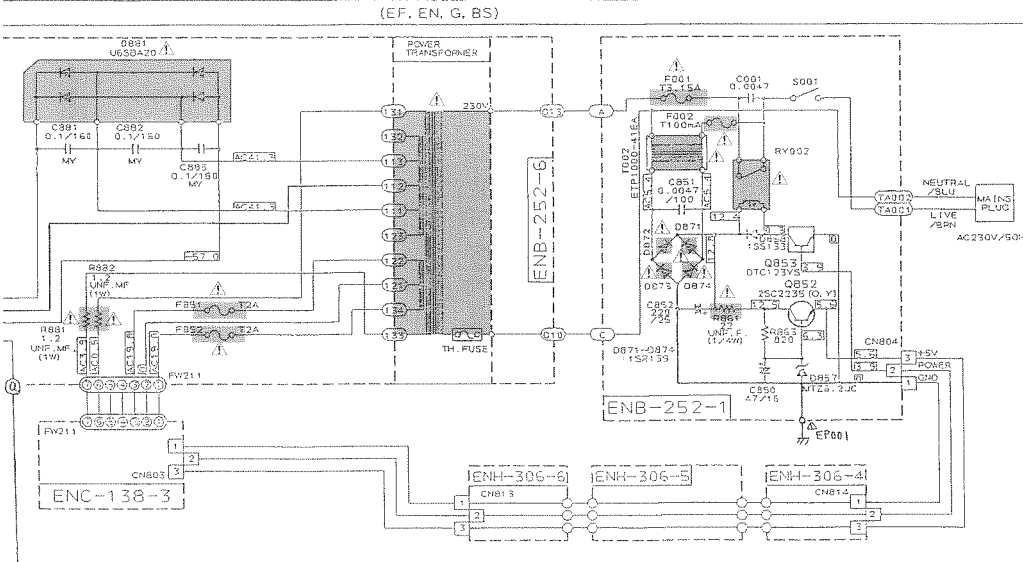

■ Front & System control section

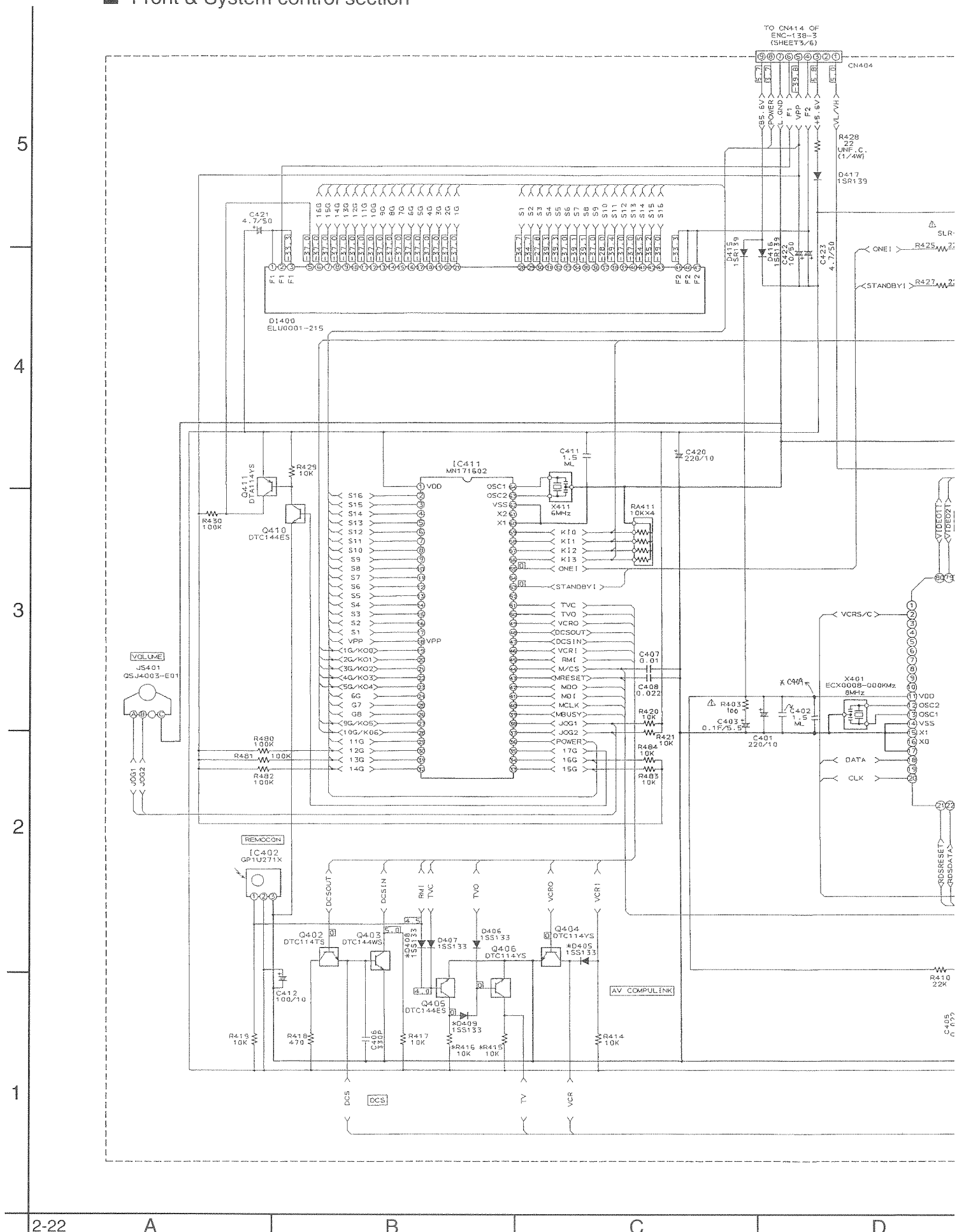

ENB-252-2

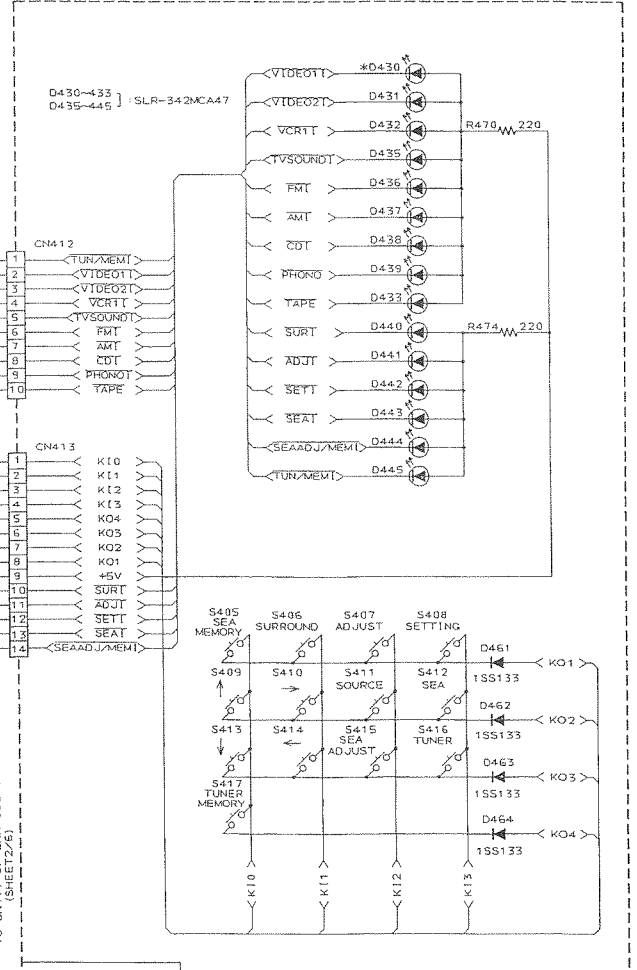
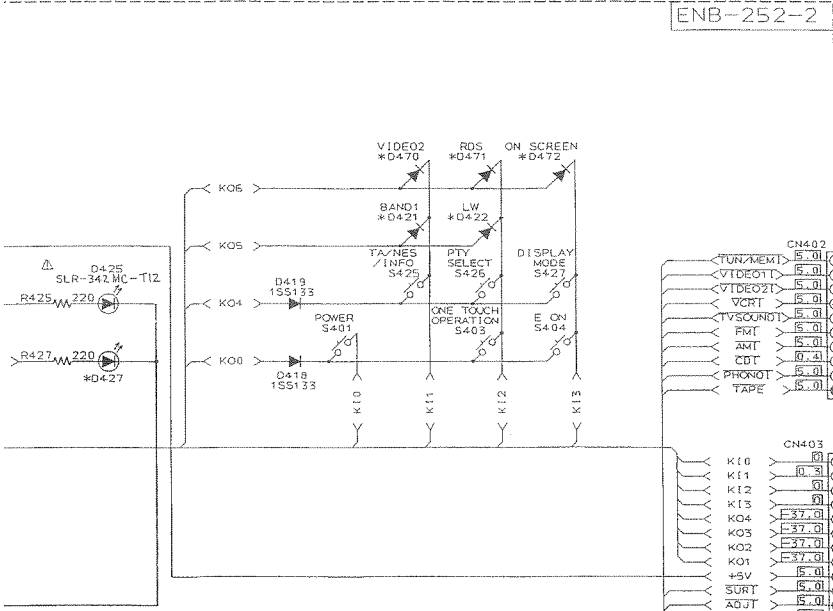

ENB-252-3

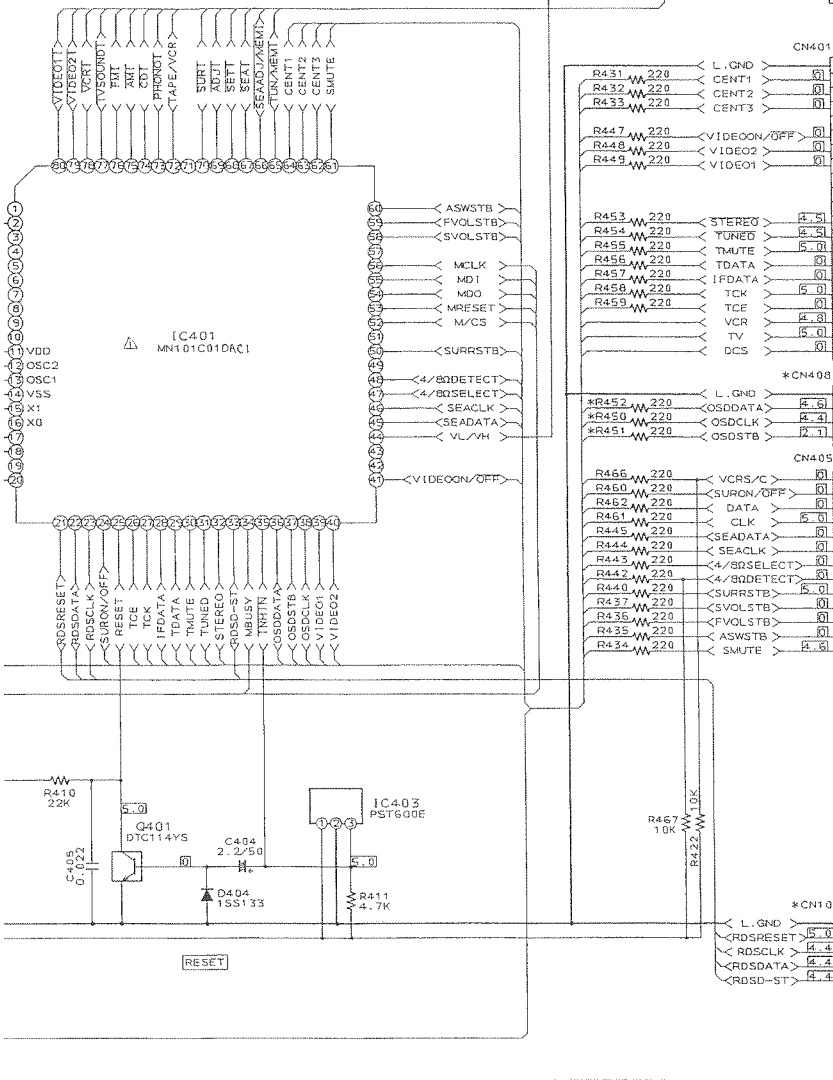

TO CN418 OF ENC-138-2 (SHEET3/6)

TO CN415 OF ENC-138-1 (SHEET3/6)

TO CN112 OF ENA-178 (SHEET6/6)

* MARK LIST

MARK	RX-772V J.C	RX-630R BS, EF, EN, G	RX-730R BS, EF, EN, G
D421	NONE	USED	USED
D422	USED	NONE	NONE
D427	SLR-342VCA47	SLA-380JTT31	SLA-380JTT31
D430	NONE	NONE	USED
D470	NONE	NONE	USED
D471	USED	NONE	NONE
D472	NONE	USED	NONE
CN102	NONE	USED	USED
CN408	USED	NONE	USED
R450	USED	NONE	USED
R451	USED	NONE	USED
R452	USED	NONE	USED
R415	USED	NONE	NONE
R416	USED	NONE	NONE
D405	USED	NONE	NONE
D408	USED	NONE	NONE
D409	USED	NONE	NONE
C409	NONE	0.047	0.047

P2-23-a

P2-23-b

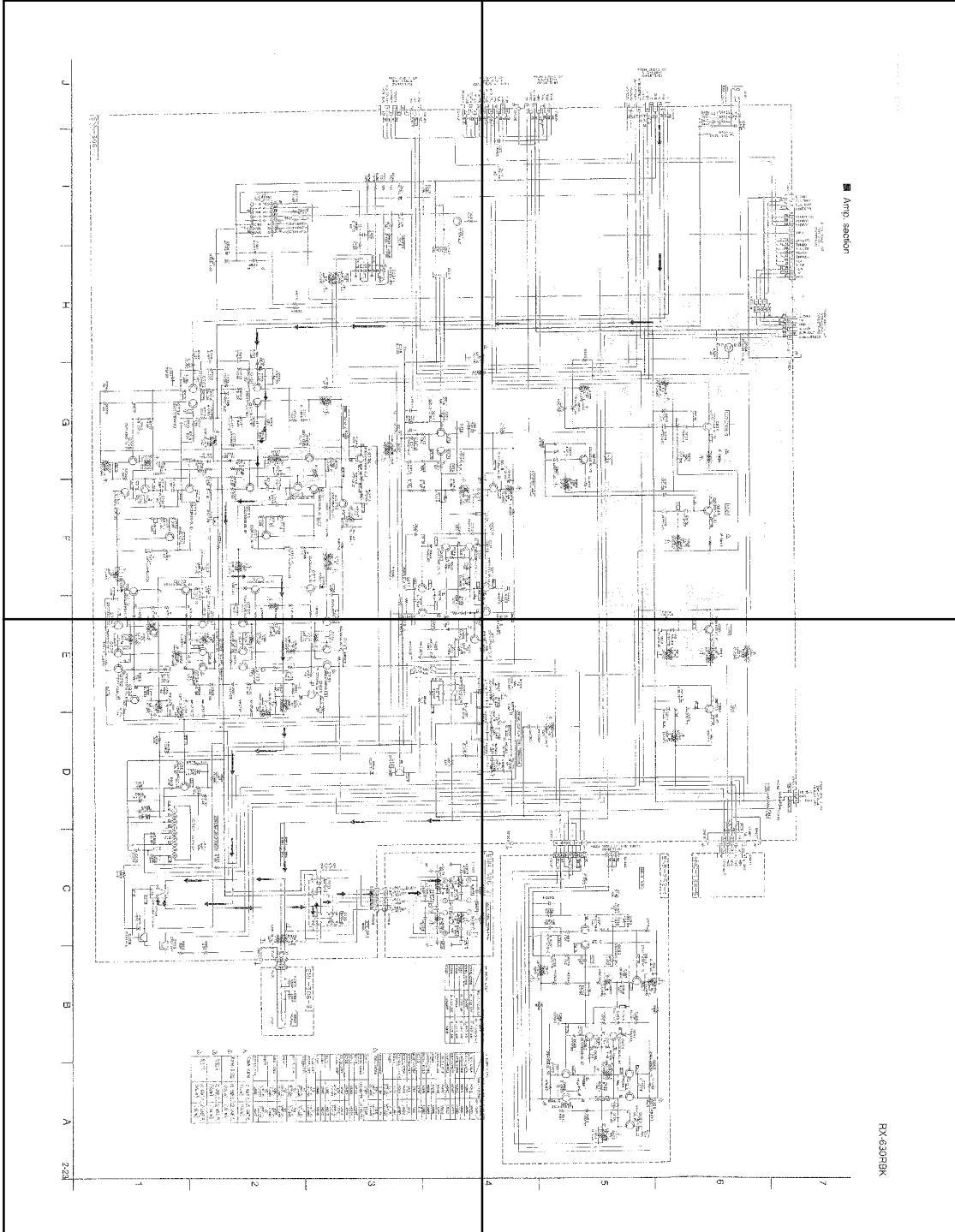

P2-23-c

P2-23-d

J

H

G

F

ENH-306-1

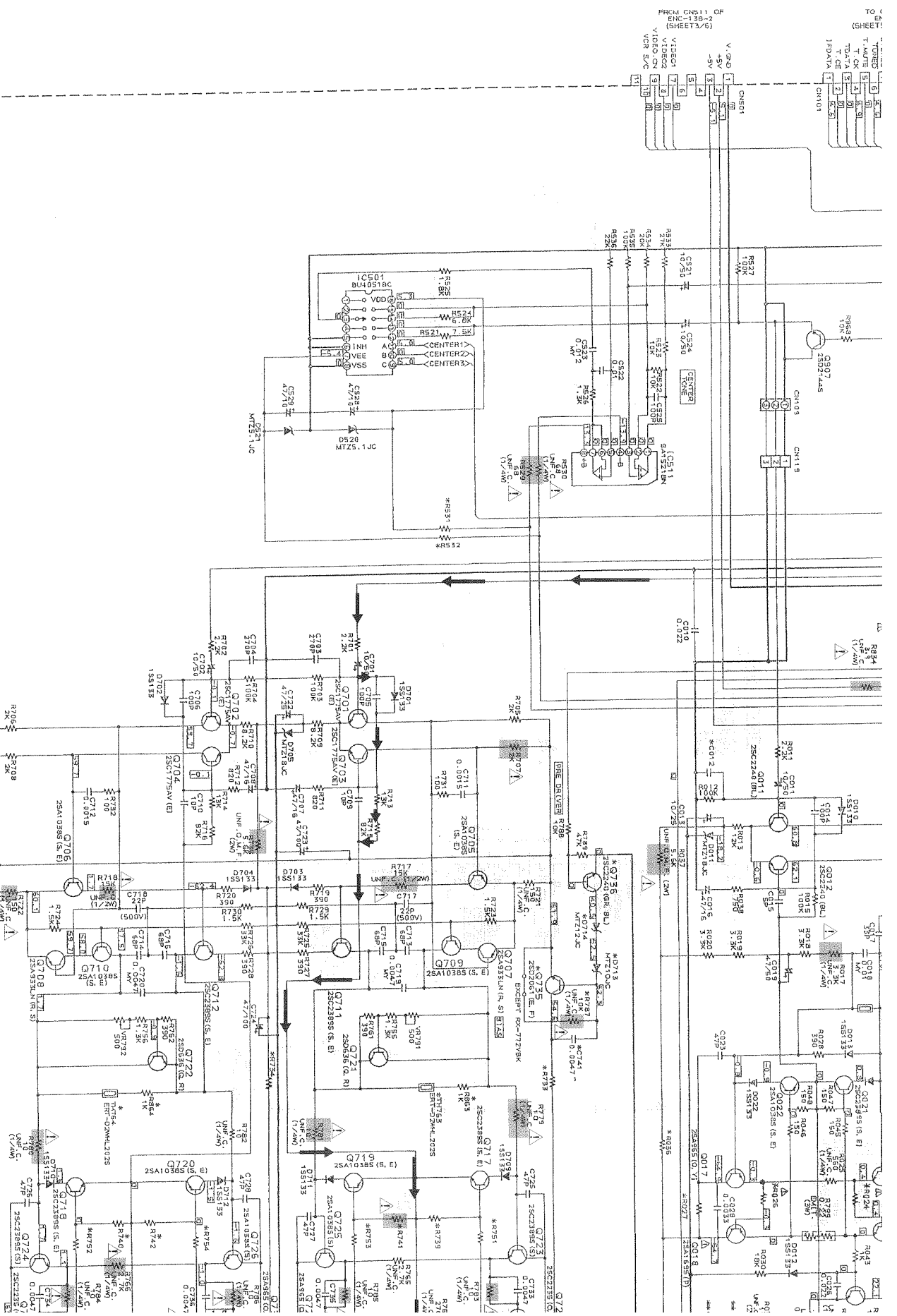

Amp. section

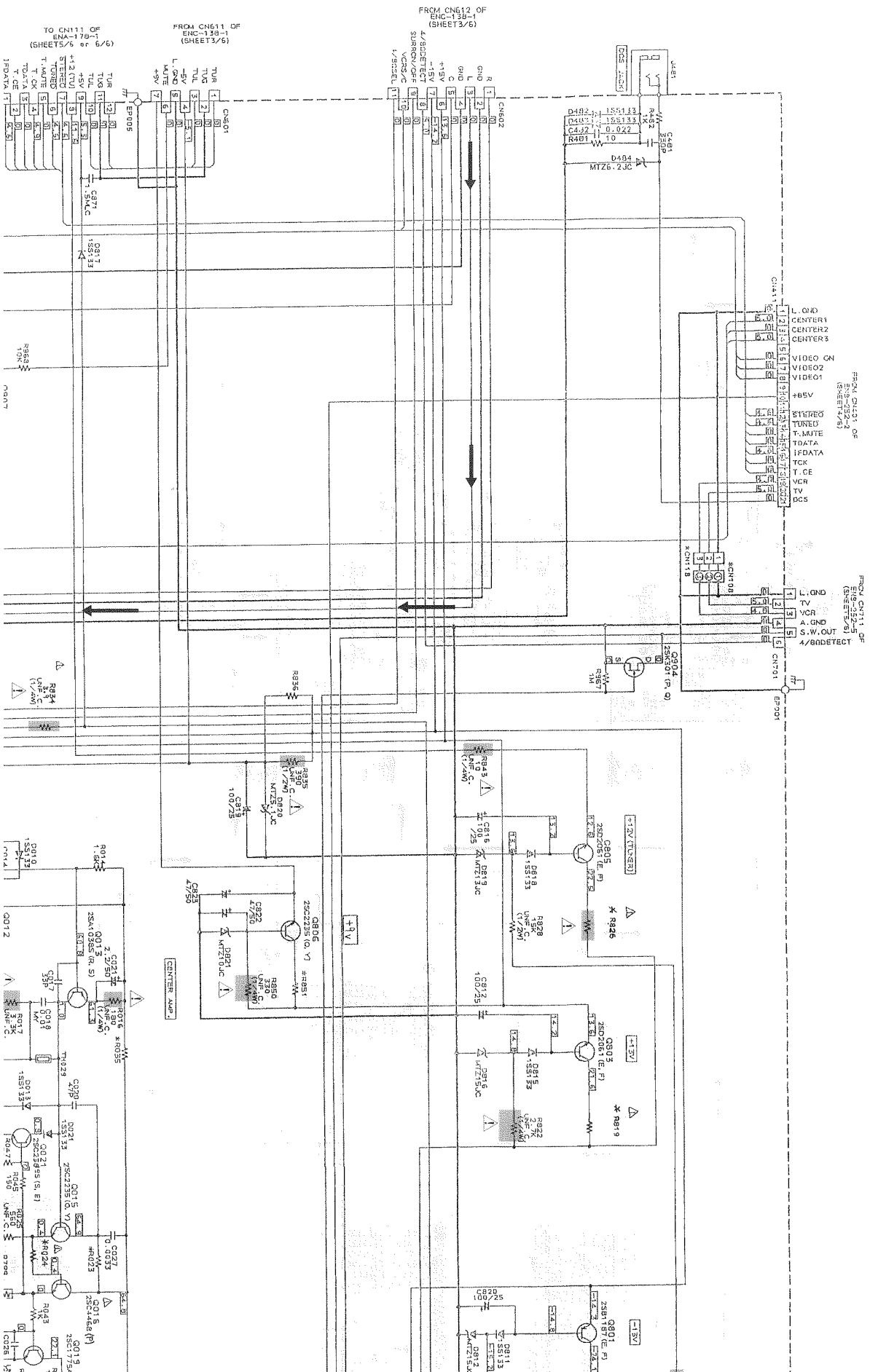

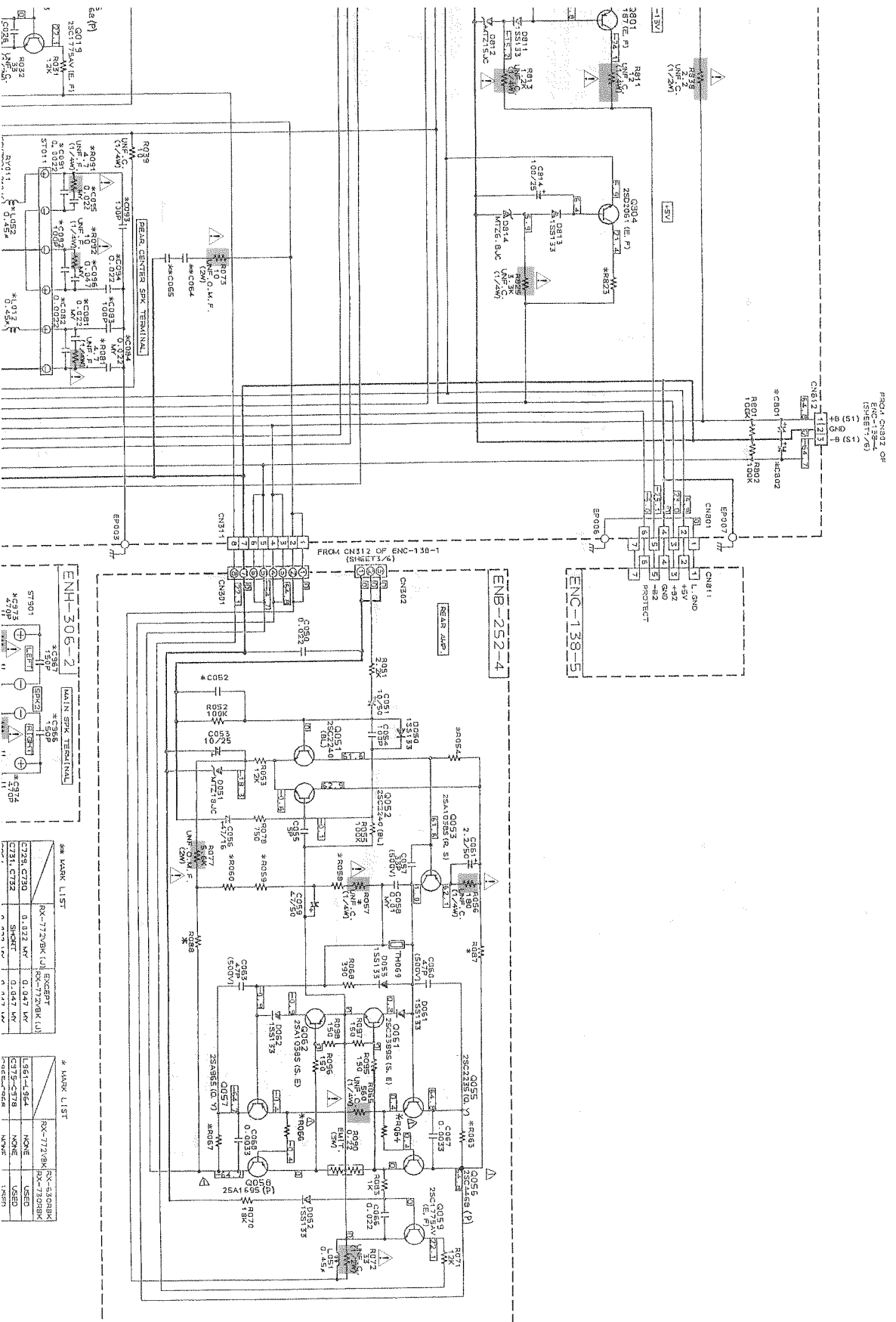

P2-24-a

P2-24-b

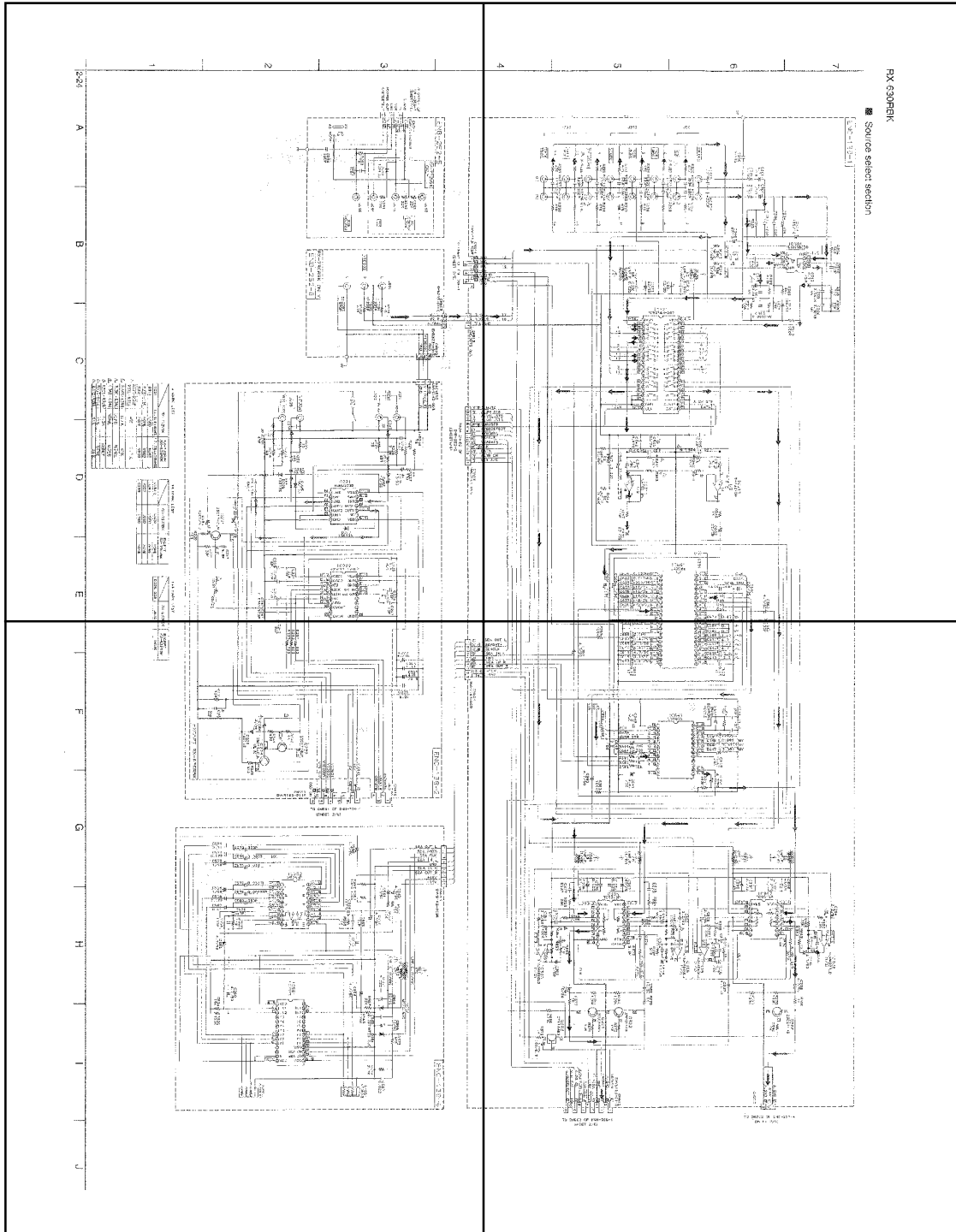

P2-24-c

P2-24-d

1

2

3

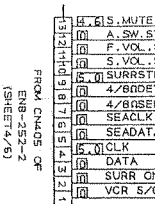
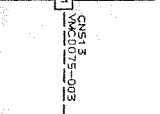
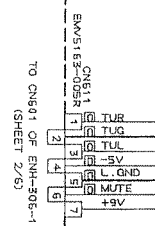
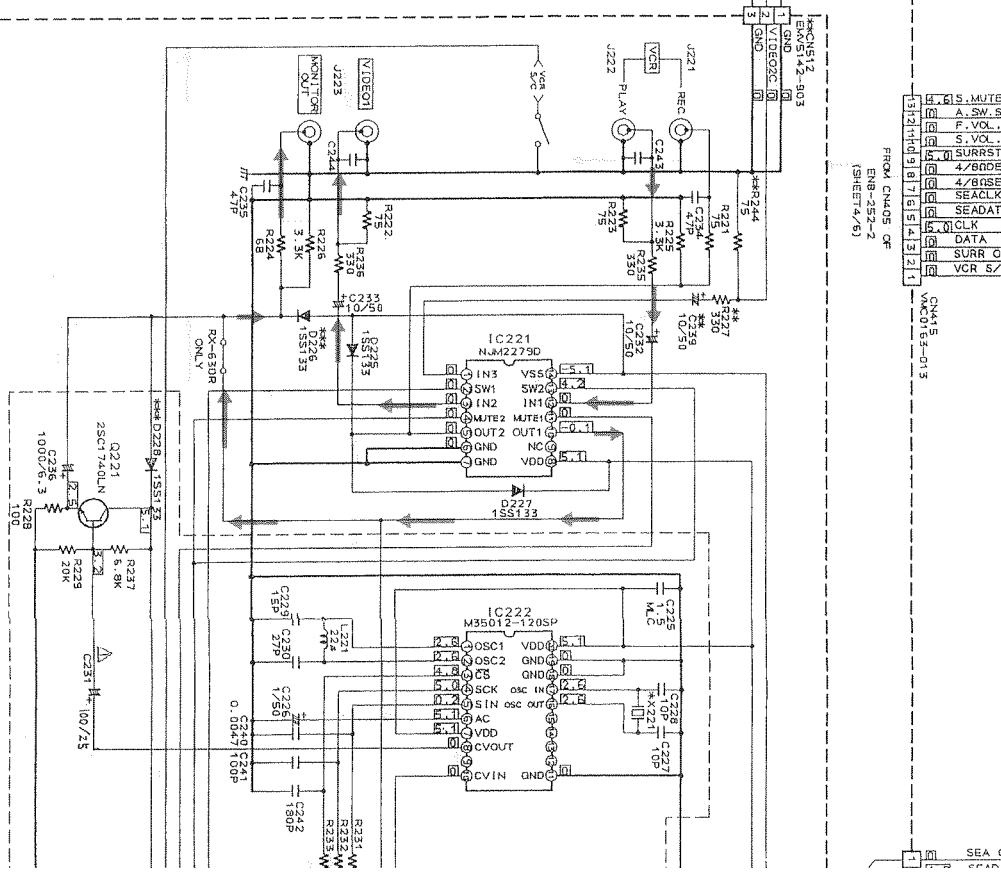
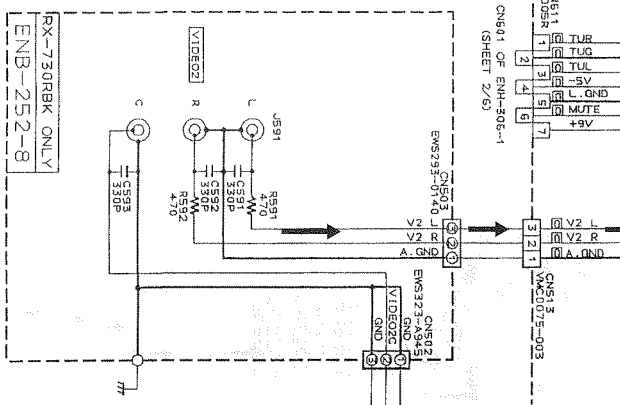
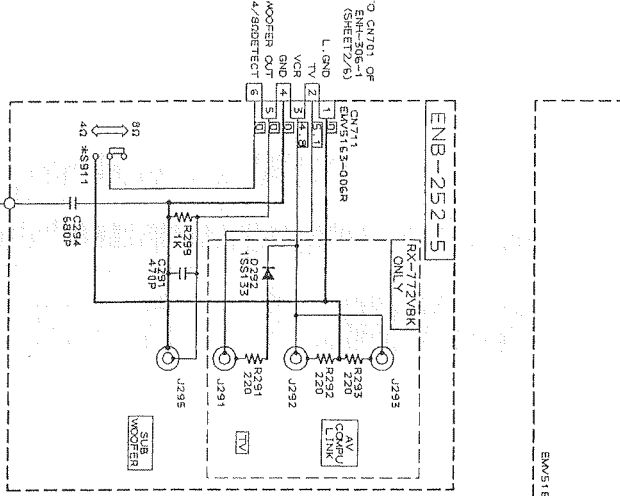

* MARK LIST

** MARK LIST

*** MARK LIST

X221	RX-772VBR	RX-430RBK	RX-430RBK
S911	14.31616MHz	17.734475MHz	NONE
C223-238	USED	NONE	NONE
D224	NONE	USED	USED
R227	R227	NONE	USED
R228	R228	470	2.2K
R229	R229	100K	47K
R230	R230	USED	NONE
R231	R231	NONE	USED
R232	R232	4.3K	SHORT
R233	R233	10K	NONE
R234	R234	50K	50K

CN611	USED	EXCEPT	EXCEPT
R244	USED	NONE	EXCEPT
R227	USED	NONE	EXCEPT
C239	USED	NONE	NC

D226	220	USED	EXCEPT
------	-----	------	--------

Source select section

ENC-138-1

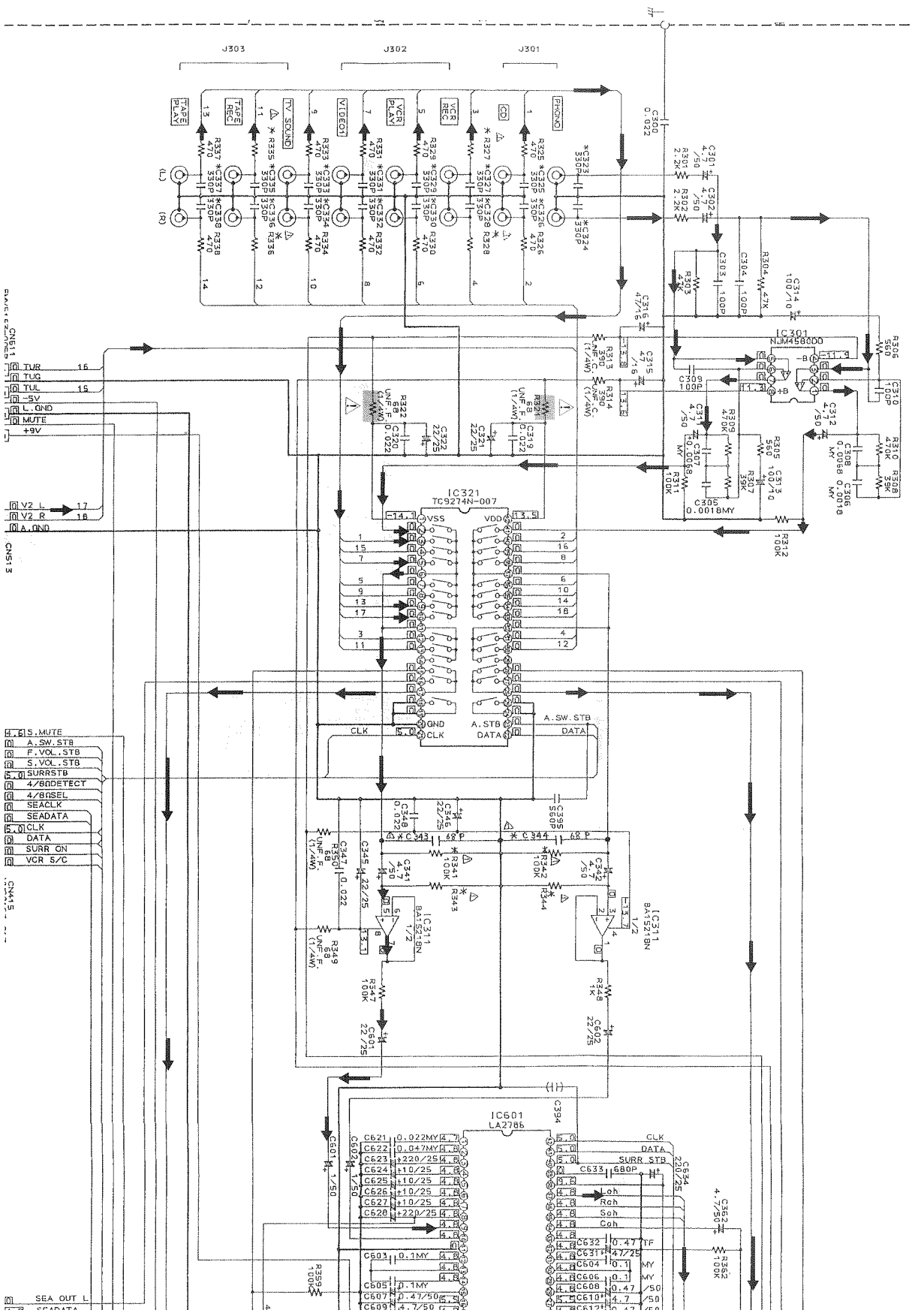

4 5 6 7

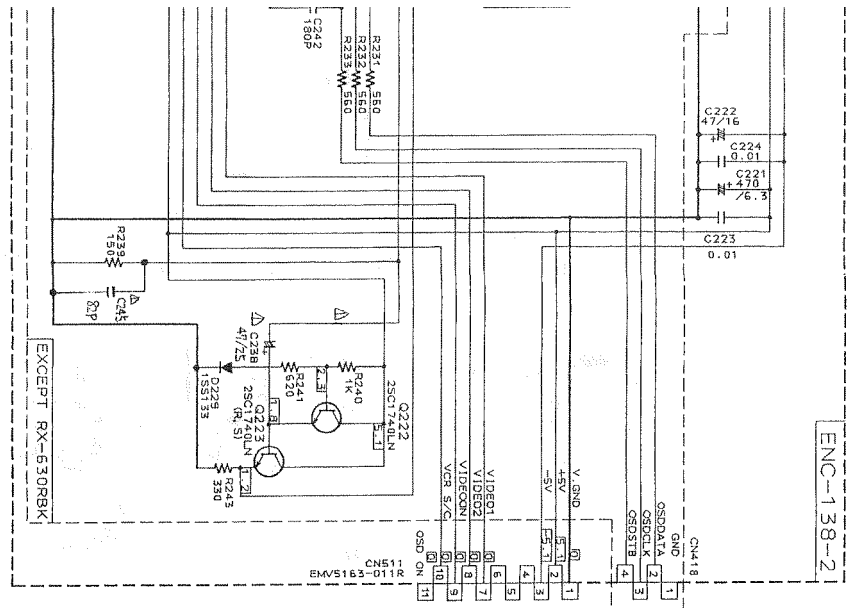
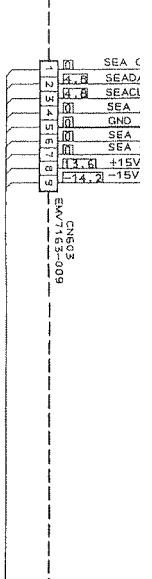

TO CN501 OF ENH-306-1 (SHEET 2/6)

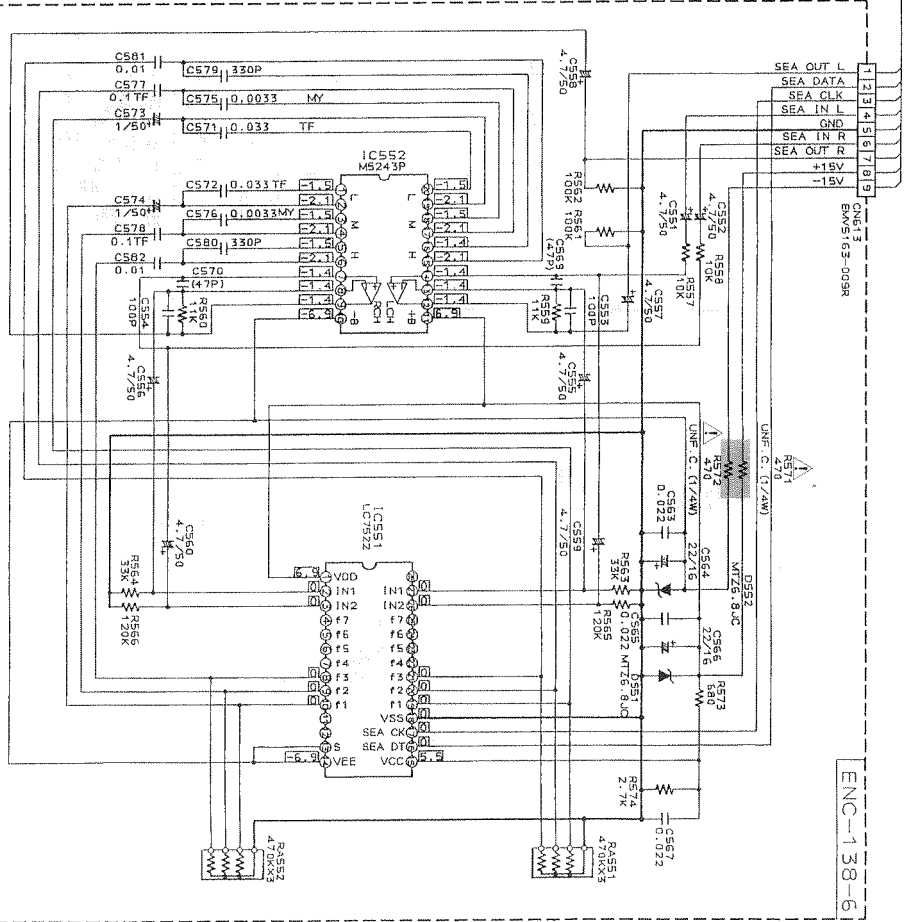

EXCEPT	RK
EX-630RBK	
NONE	

F G H I J

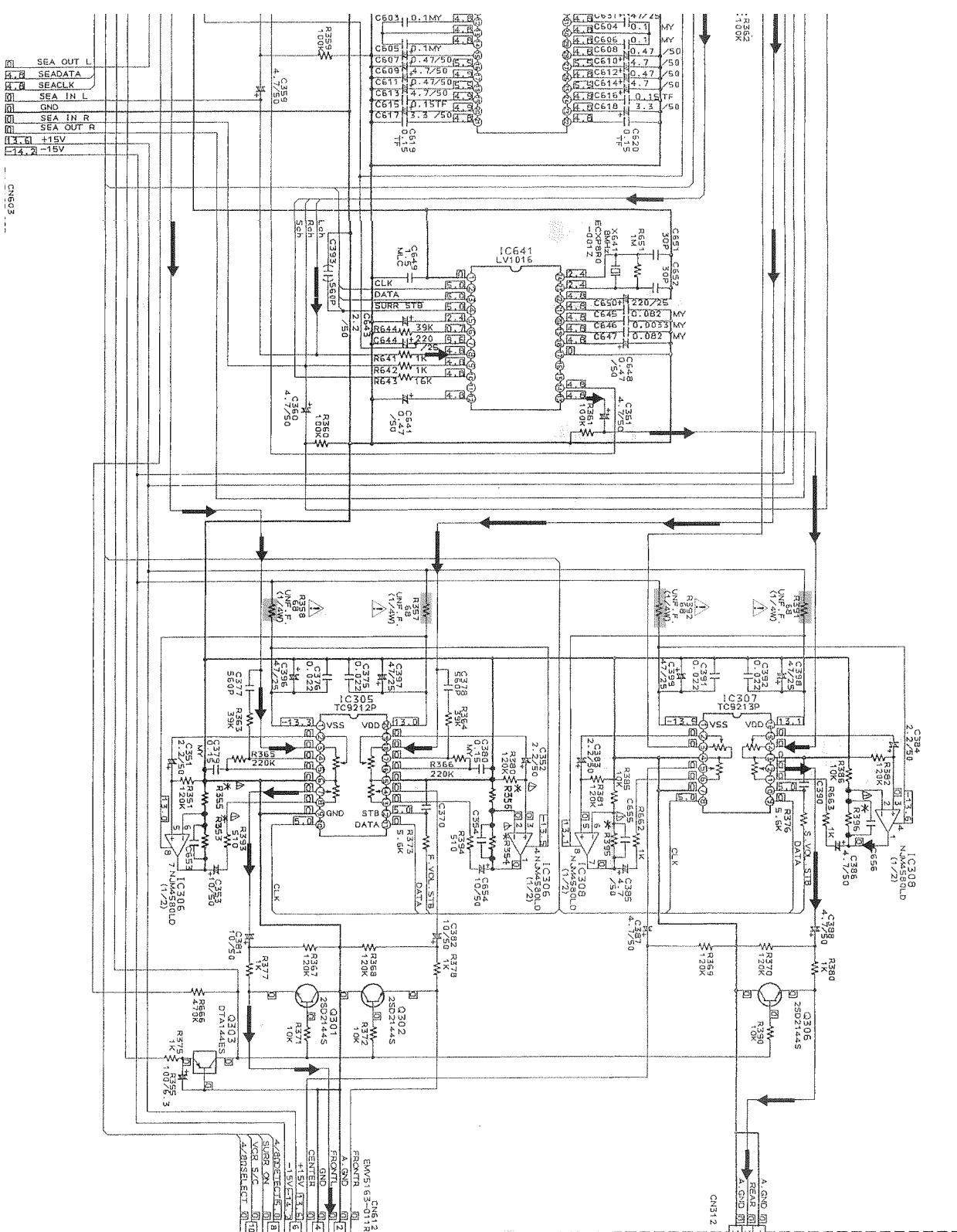

SEA OUT L
SEA IN L
SEA IN R
SEA OUT R
+15V
-15V

CN503

TO CN602 OF ENH-106-1
SHEET 2/6

TO CN302 OF ENB-252-4
SHEET 2/6

■ Tuner section

FOR J, C
ENA-178

□ : FM 87.5MHz NO SIGNAL
() : MW522 KHz NO SIGNAL

5

4

3

2

1

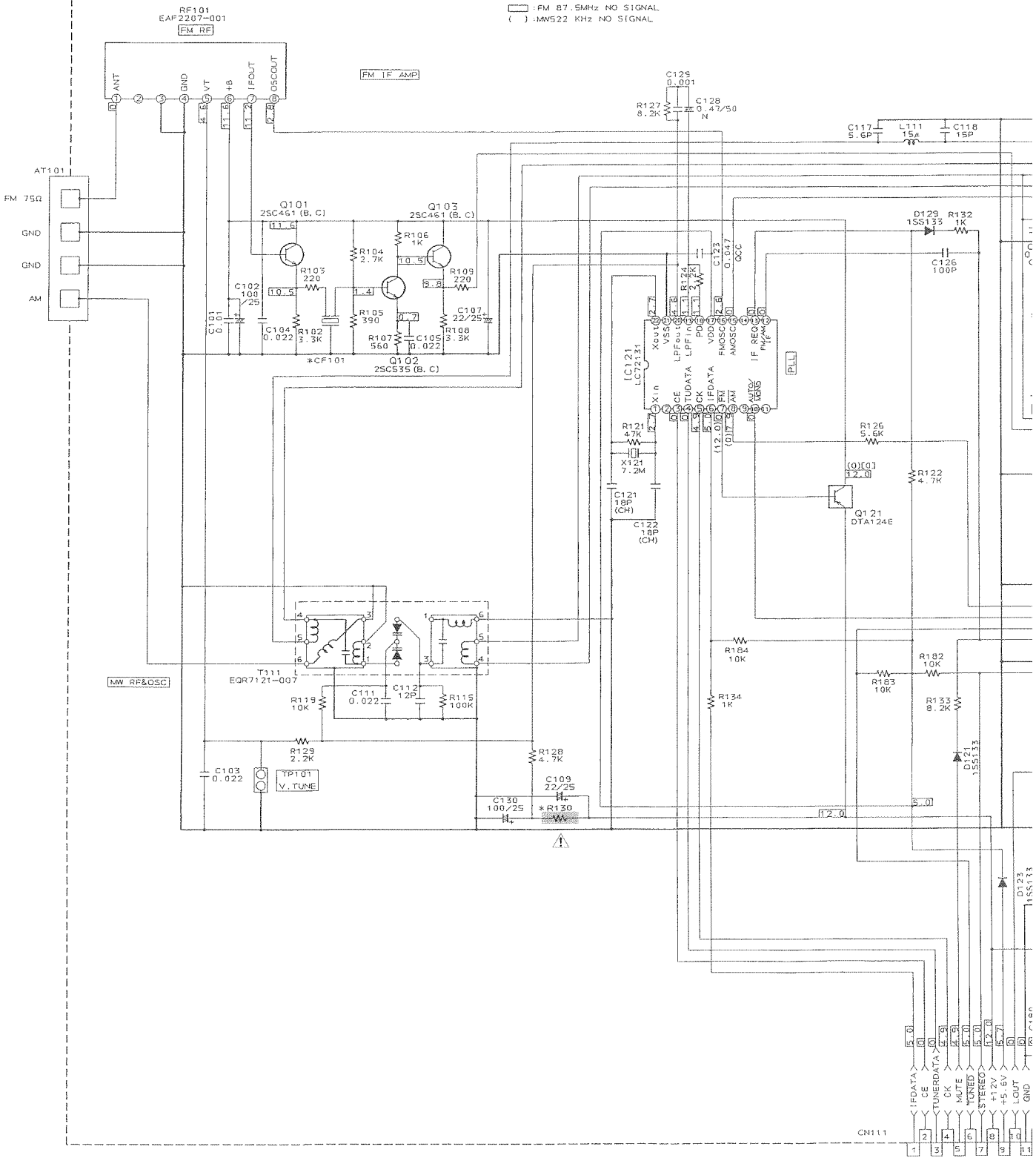

CN111

1	2	3	4	5	6	7	8	9	10	11
IFDATA	CE	TUNERDATA	CK	MUTE	TONED	STEREO	+1.2V	+5.5V	LOUT	GND

A B C D

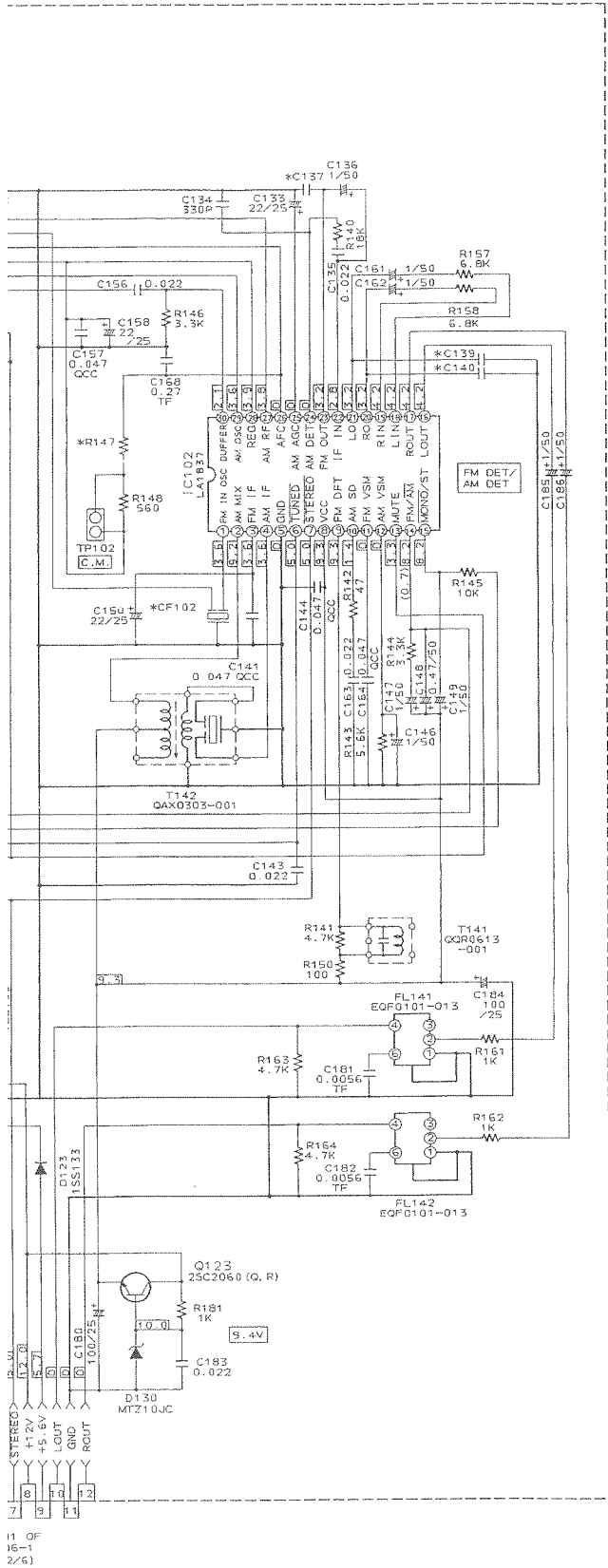

* MARK

C137	J, C
C139, 140	0.033TF
CF101, 102	QAX0284-001Z
R130	68 UNF, C. (1/4W)
R147	15K

RF101
EAF2207-001

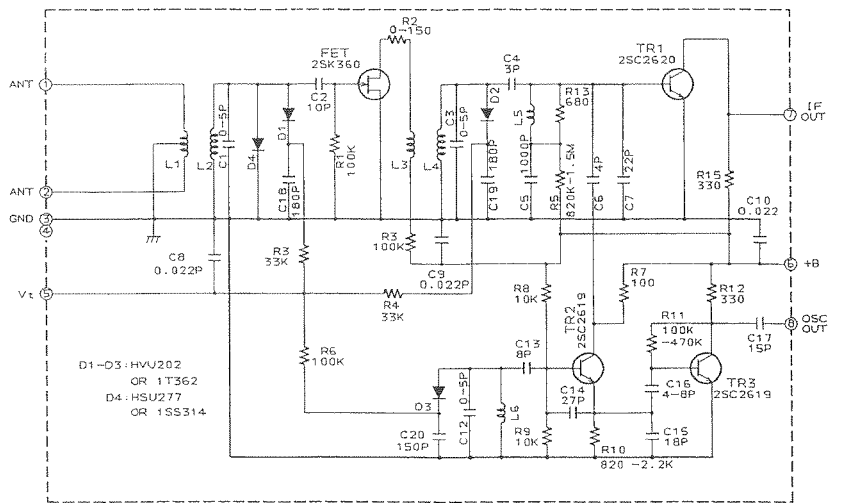

- D1-D3: HVJ202 OR 1T362
- D4: HSU277 OR 1SS314

11 OF
16-1
2/6)

■ Front & System Control / Power Supply P.C.Board

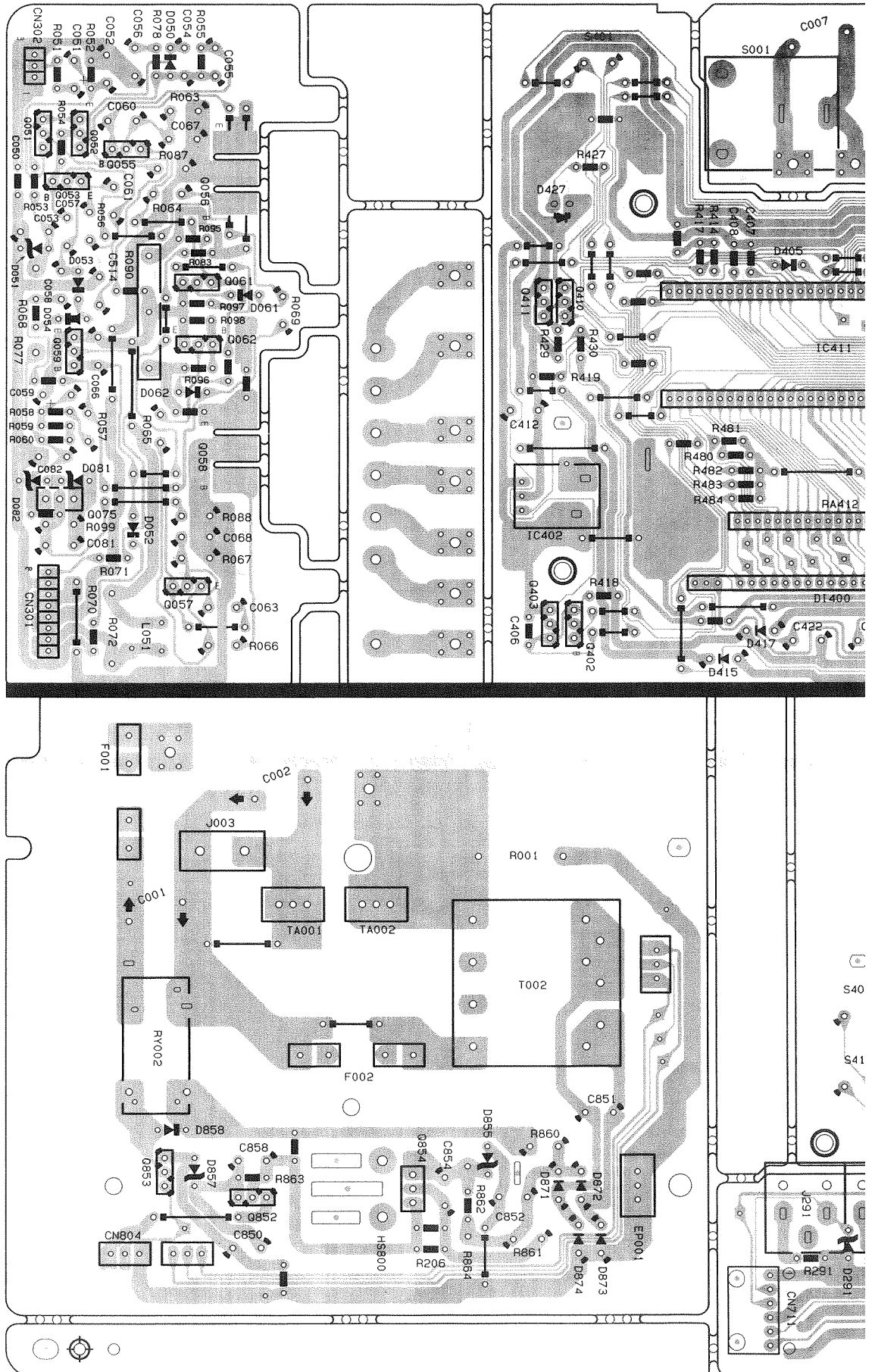

007

S427

S425

S404

R466

02

01

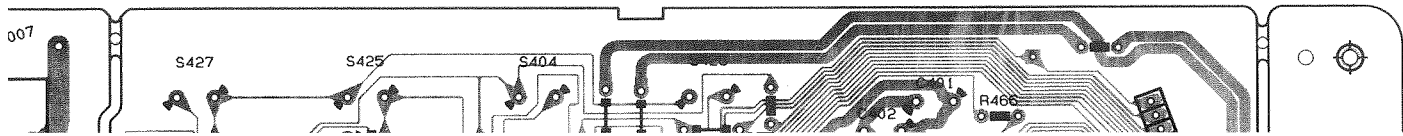

■ Source Select & Video P.C.Board

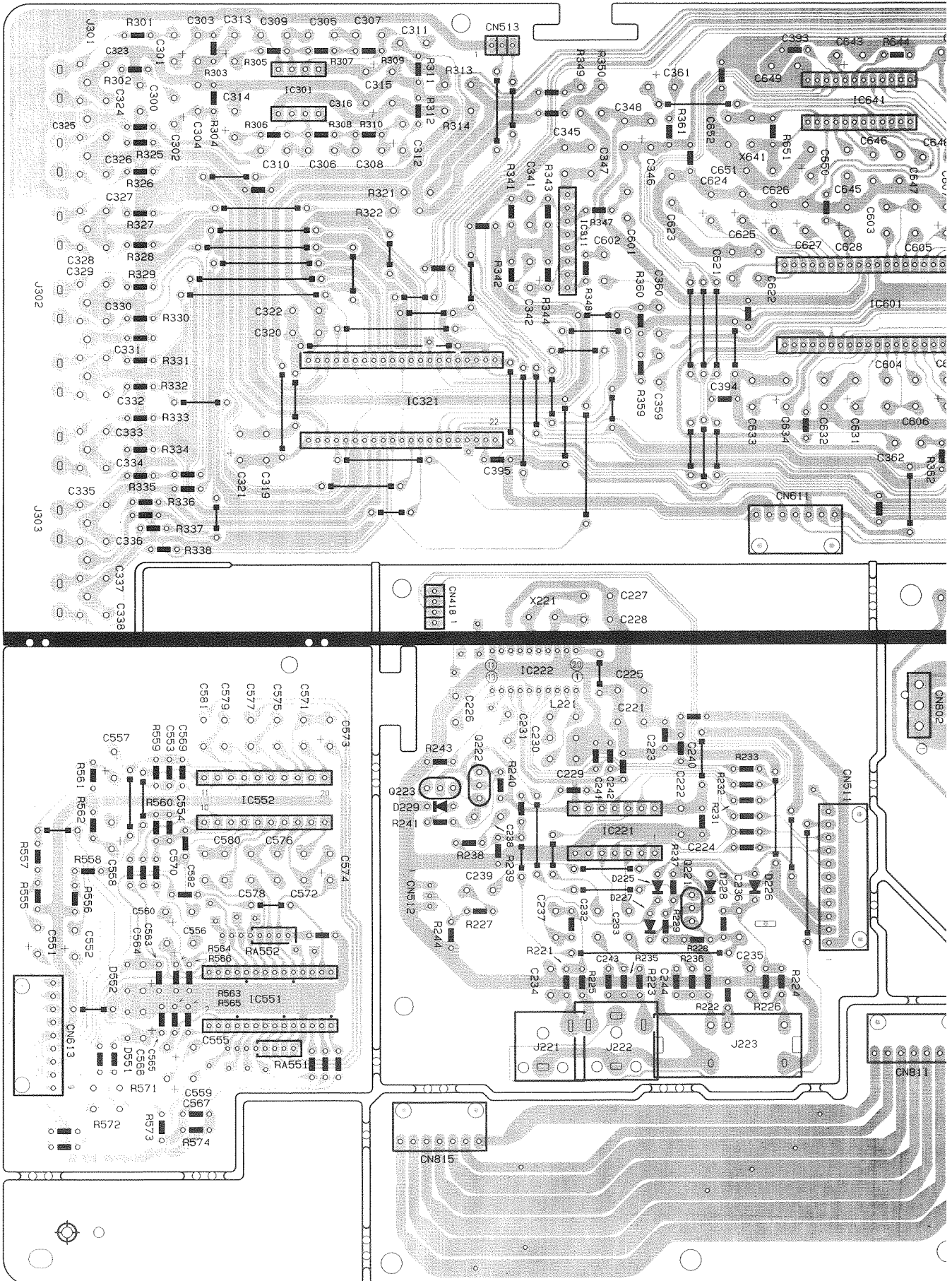

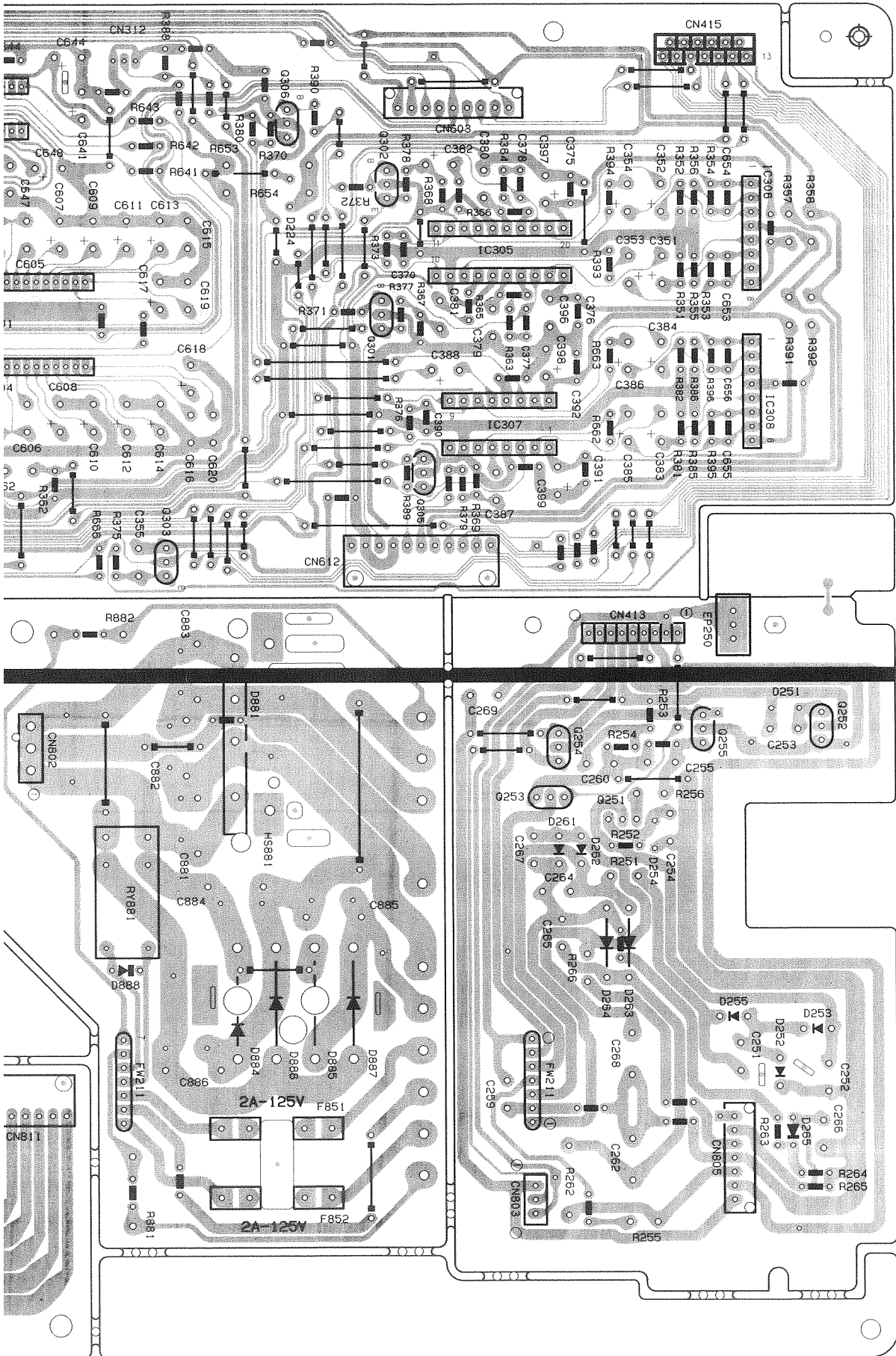

■ Tuner P.C.Board

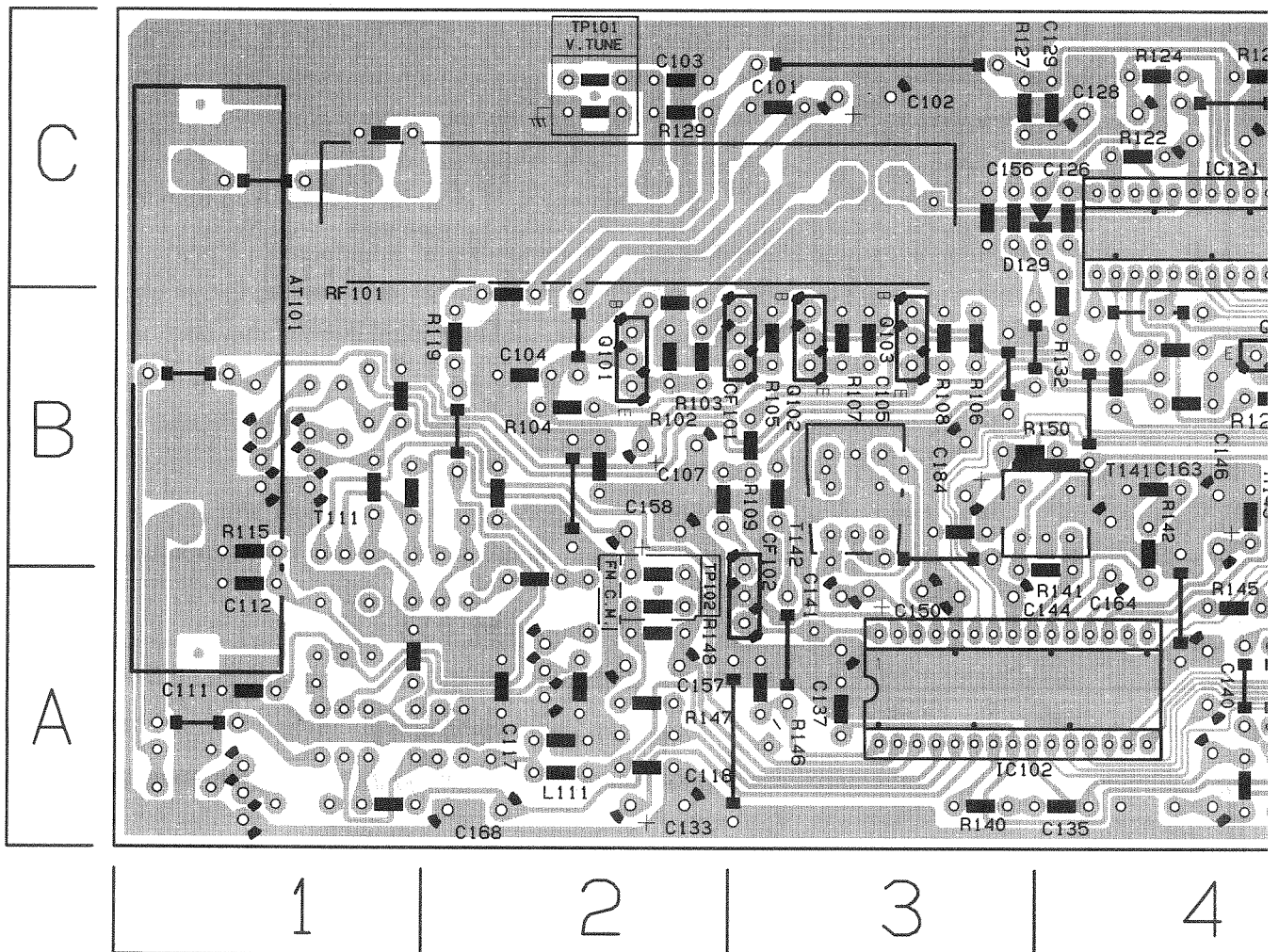

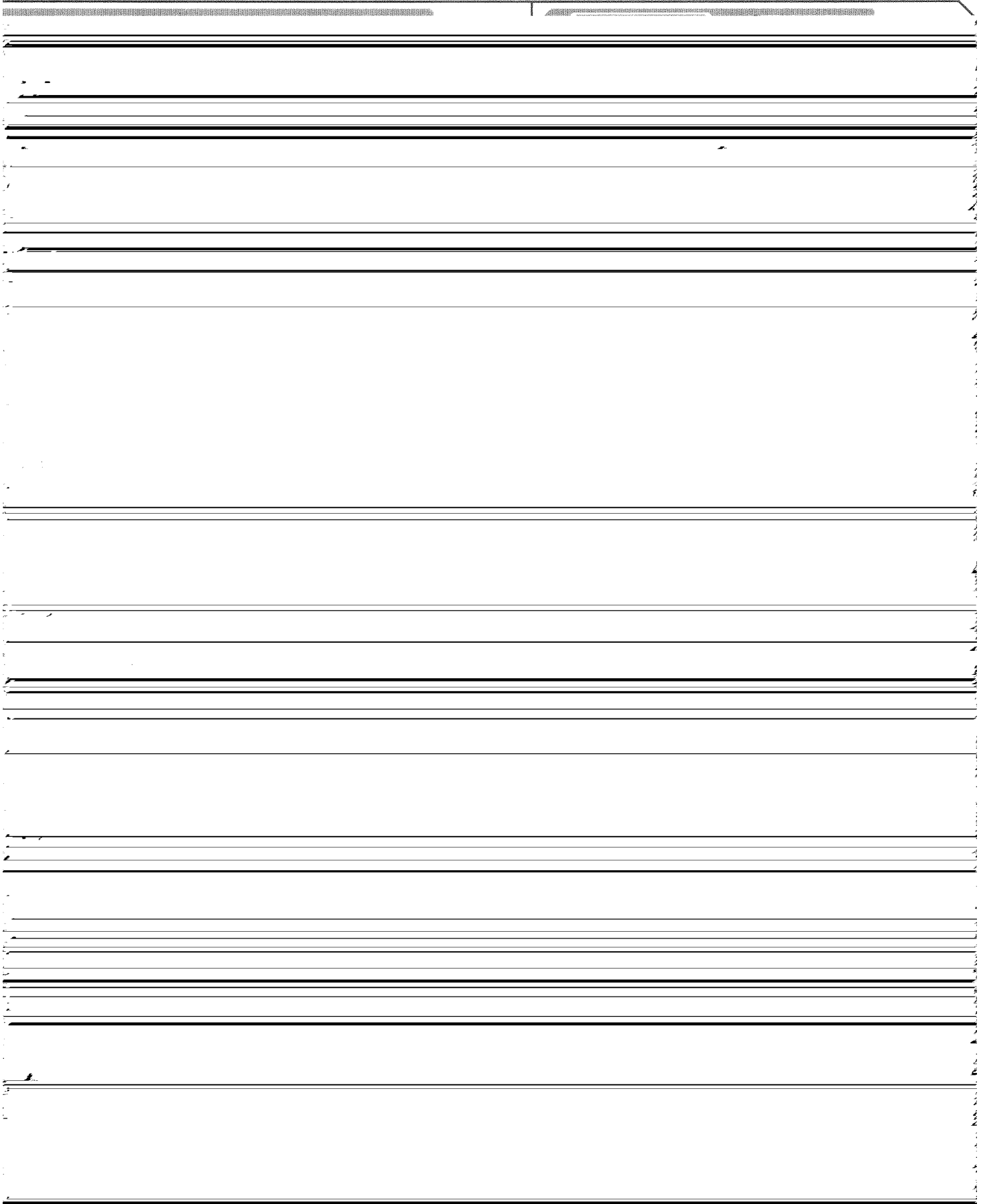

PARTS LIST

* All printed circuit boards and its assemblies are not available as service parts.

<p>The Marks for Designated Areas BS --- the U.K. EF --- Continental Europe Except Germany EN --- Nordic Countries G --- Germany</p>

- Contents -

General Exploded View and Parts List -----	3-3
Electrical Parts List	
(TUNER) -----	3-5
(POWER AMP) -----	3-6
(DISPLAY CONTROL) -----	3-11
(SOURCE SELECT VIDEO OUTPUT)-----	3-13
Accessories List -----	3-16
Packing Materials and Part Numbers -----	3-17

RX-630RBK

General Exploded View and Parts List

Block No. M1MM

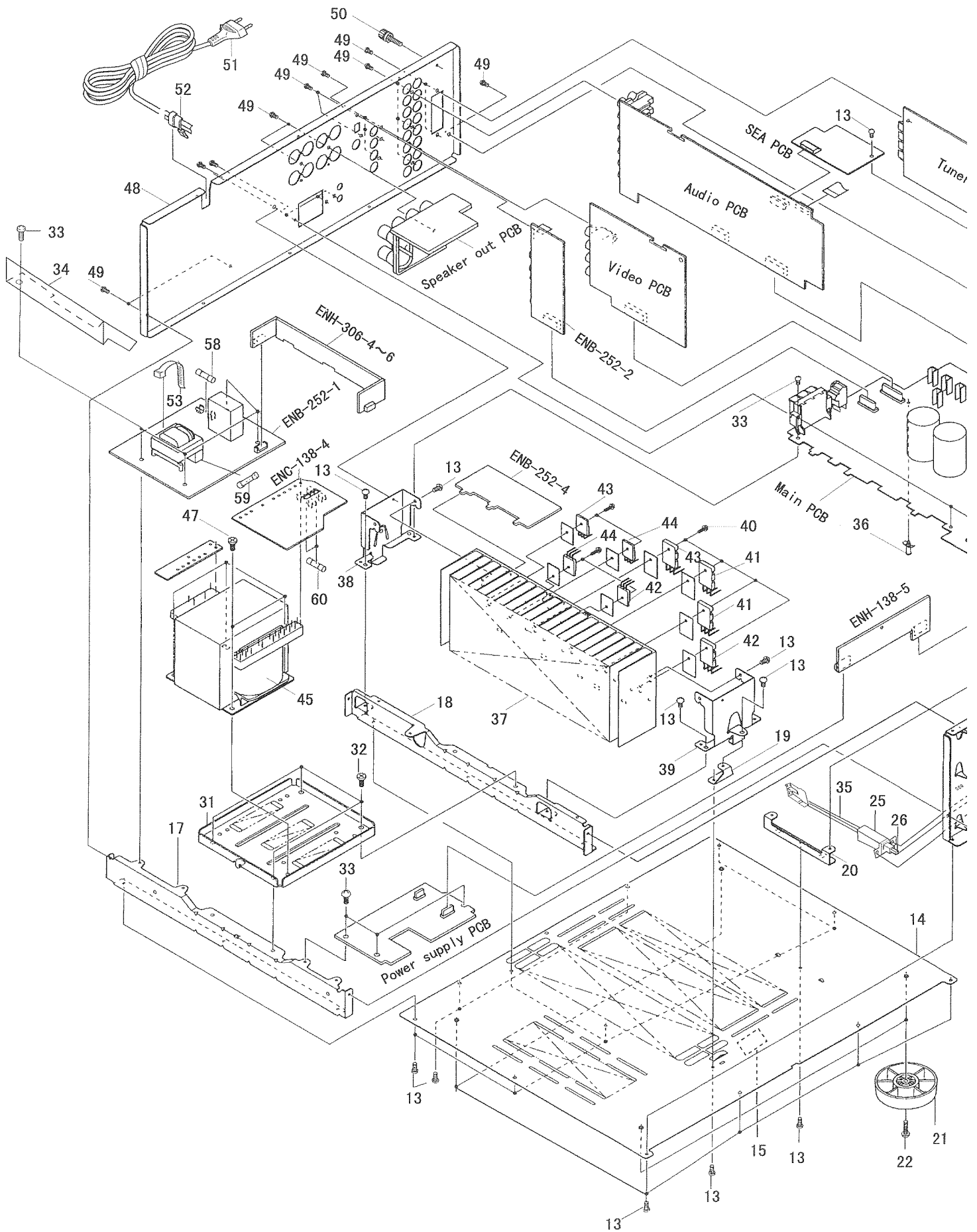

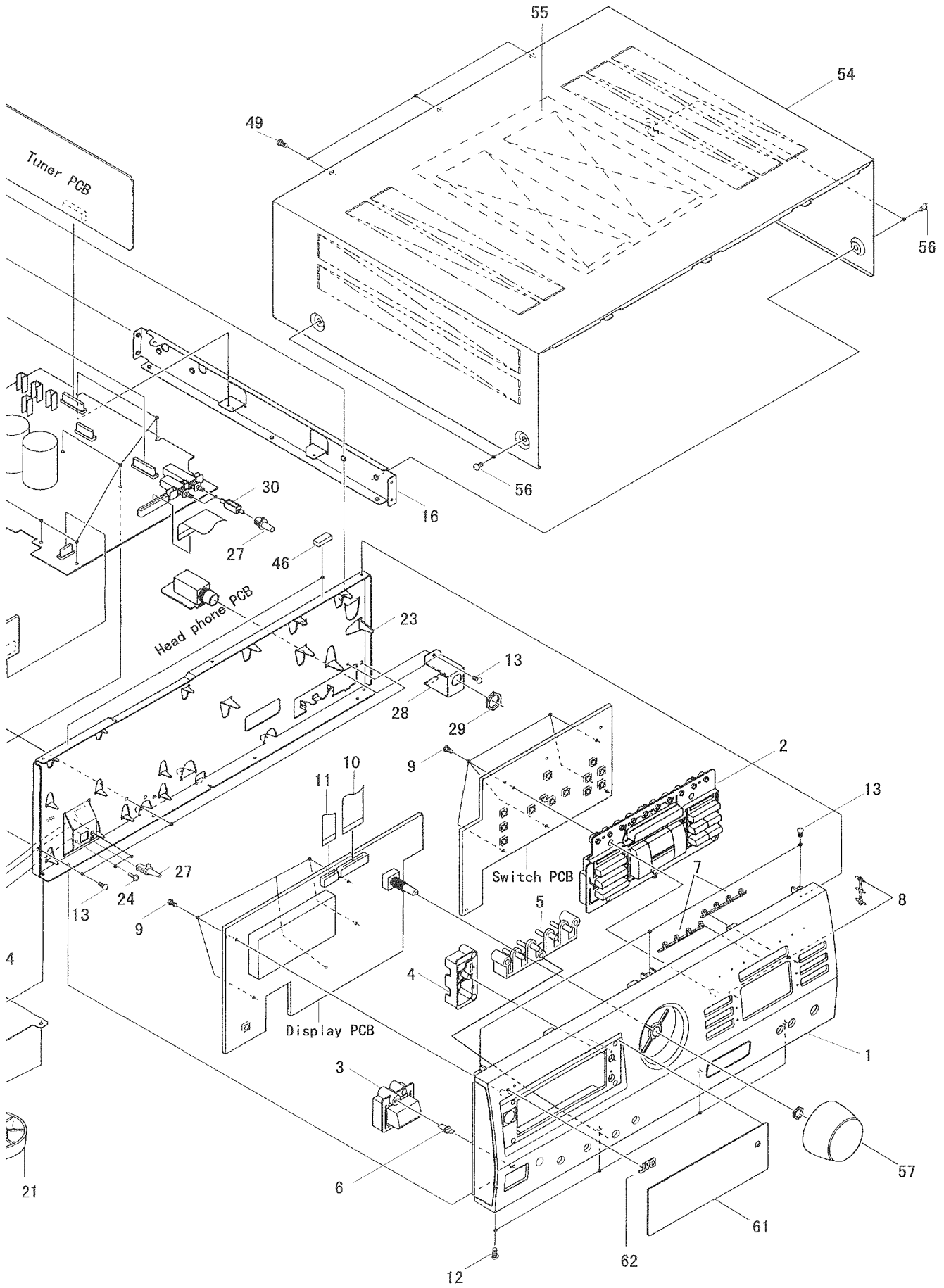

■ Parts List

Block No. **M1M1M1**

△	Item	Parts Number	Parts Name	Q'ty	Description	Area
	1	LE10082-007AKP	FRONT PANEL	1		
	2	LE20133-002AKP	PUSH BUTTON	1	SOURCE	
	3	LE30367-002A	PUSH BUTTON	1	POWER	
	4	LE30369-003A	PUSH BUTTON	1	ONE TOUCH /	
	5	LE30371-001AKP	PUSH BUTTON	1	RDS	
	6	LE40148-001A	INDICATOR LENS	1	POWER	
	7	LE30372-001A	INDICATOR LENS	2	SOURCE	
	8	LE30373-001A	INDICATOR LENS	2	SURROUND	
	9	SDSF2608Z	SCREW	10	F. C. B-F. PANEL	
	10	VWF1221-32TTBV	FLAT WIRE	1		
	11	VWF1213-32TTBV	FLAT WIRE	1		
	12	SDSG3008M	TAPPING SCREW	4	F. PANEL-F. BKT	
	13	SBSG3008CC	TAPPING SCREW	27	F. PANEL-F. BKT	
	14	E102820-004SM	BOTTOM PLATE	1		
	15	E70115-002	CAUTION LABEL	1		
	16	E208081-003SM	SIDE BRACKET	1	RIGHT	
	17	E208548-001SM	SIDE BRACKET	1	LEFT	
	18	E208549-001SM	CENTER BRACKET	1		
	19	E68587-010	BRACKET	1		
	20	E407984-001SM	P. W. BOARD HOLDER	1		
	21	VJF4039-00P	FOOT ASSY	4		
	22	SBST3010Z	TAPPING SCREW	4	FOOT	
	23	LE10084-002A	FRONT BRACKET	1		
	24	SBST3006CC	TAPPING SCREW	2	1ST SW	
	25	E71004-001	SWITCH COVER	1	1ST SW	
△	26	QSP4C11-E03	PUSH SWITCH	1	1ST SW	
	27	E407321-002SM	PUSH BUTTON	3	1ST SW	
	28	LE40139-001A	HEADPHONE BRACKET	1		
	29	VKZ4150-001	NUT	1		
	30	LE30377-001A	PUSH SHAFT	2		
	31	LE30376-001A	TRANSFORMER BRACKET	1		
	32	E65389-006	SPECIAL SCREW	4	T. BKT-FRAME	
	33	GBSG3008CC	TAPPING SCREW	14	AC 2ND. -FRAME	
	34	LE30495-002AKP	PROTECT COVER	1		
	35	EWS282-010J	SOCKET WIRE ASSY	1		
	36	E310244-003	FASTENER	1		
	37	E309170-004SM	HEAT SINK	1		
	38	E308836-003SM	HEAT SINK BRACKET	1		
	39	E308836-004SM	HEAT SINK BRACKET	1		
	40	E73525-003	SCREW	8	P. TR	
	41	2SD2155LB (R, O)	SI. TRANSISTOR	2	Q731, Q732	
	42	2SB1429LB (R, O)	SI. TRANSISTOR	2	Q733, Q734	
	43	2SC4468/P/-F1	SI. TRANSISTOR	2	Q056, Q016	
	44	2SA1695/P/-F1	SI. TRANSISTOR	2	Q058, Q018	
	45	QQT0171-001KP	TRANSFORMER	1		
	46	E306805-146	SPACER	2	F. BKT	
	47	E65389-006	SPECIAL SCREW	4	P. TRANS	
	48	LE10085-011AKP	REAR PANEL	1		
	49	E73273-006	SPECIAL SCREW	21	R. PANEL-FRAME	
	50	E409257-001	EARTH TERMINAL	1		
△	51	QMP39E0-200	POWER CORD	1		EFENG
△		QMP5530-0085BS	POWER CORD	1		BS

Block No. **M1MM**

△	Item	Parts Number	Parts Name	Q'ty	Description	Area
△	52	QHS3771-108	CORD STOPPER	1		
	53	E307572-001	VINYL TIE	1		
	54	LE20132-002A	METAL COVER	1		
	55	E208294-001SMKP	PROTECT SHEET	1		
	56	E61660-004	SPECIAL SCREW	4	M. COVER-FRAME	
	57	E309823-001SM	VOLUME KNOB	1		
△	58	QMF51E2-3R15J1	FUSE	1	F001	
	59	QMF51E2-R10SBS	FUSE	1	F002	BS
△		QMF51A2-R10S	FUSE	1	F002	EFENG
△	60	QMF51E2-2R0	FUSE	2		
	61	LE30374-003A	WINDOW SCREEN	1		
	62	VJD5429-001	JVC MARK	1		
	-	E409396-001	CAUTION LABEL	1		

■ Electric Parts List (Tuner P. W. B)

△	Item	Parts Number	Description	Area
		I. C. S		
	IC102	LA1837	I. C (MONO-ANALOG)	
	IC121	LC72131	I. C (M)	
	IC191	LC7073	I. C (DIGI-MOS)	
	IC192	SAA6579	I. C (M)	
		DIODES		
	D121	1SS133	SI. DIODE	
	D123	1SS133	SI. DIODE	
	D129	1SS133	SI. DIODE	
	D130	MTZ10JC	ZENER DIODE	
	D131	1SS133	SI. DIODE	
		TRANSISTORS		
	Q101	2SC461	SI. TRANSISTOR	
	Q102	2SC535	SI. TRANSISTOR	
	Q103	2SC461	SI. TRANSISTOR	
	Q111	2SD2144S (VW)	SI. TRANSISTOR	
	Q112	2SD2144S (VW)	SI. TRANSISTOR	
	Q113	2SD2144S (VW)	SI. TRANSISTOR	
	Q114	2SD2144S (VW)	SI. TRANSISTOR	
	Q121	DTA124ES	DIGITAL TRANSISTOR	
	Q123	2SC2060 (G. R)	SI. TRANSISTOR	
		CAPACITORS		
	C101	QCVB1CM-103Y	0.01MF 16V CER. CAP.	
	C102	QETN1EM-107Z	100MF 25V E. CAP.	
	C103	QCHB1EZ-223	0.022MF 25V CER. CAP.	
	C104	QCHB1EZ-223	0.022MF 25V CER. CAP.	
	C105	QCHB1EZ-223	0.022MF 25V CER. CAP.	
	C107	QETN1EM-226Z	22MF 25V E. CAP.	
	C109	QETN1EM-226Z	22MF 25V E. CAP.	
	C111	QCHB1EZ-223	0.022MF 25V CER. CAP.	
	C112	QCT300CH-120Y	12PF 50V CER. CAP.	
	C113	QCHB1EZ-223	0.022MF 25V CER. CAP.	
	C117	QCSB1HK-5R6Y	5.6PF 50V CER. CAP.	
	C118	QCSB1HJ-150Y	15PF 50V CER. CAP.	
	C121	QCT300CH-180Y	18PF 50V CER. CAP.	
	C122	QCT300CH-180Y	18PF 50V CER. CAP.	
	C123	QCC21EM-473	0.047MF 25V CER. CAP.	
	C126	QCB1HK-101Y	100PF 50V CER. CAP.	
	C128	QENB1HM-474	0.47MF 50V NP E. CAP.	
	C129	QCGB1HK-102	1000PF 50V CER. CAP.	
	C130	QETN1EM-107Z	100MF 25V E. CAP.	
	C133	QETN1EM-226Z	22MF 25V E. CAP.	
	C134	QCB1HK-331Y	330PF 50V CER. CAP.	
	C135	QCHB1EZ-223	0.022MF 25V CER. CAP.	
	C136	QETN1HM-105Z	1MF 50V AL E. CAP.	
	C137	QCB1HK-391Y	390PF 50V CER. CAP.	
	C139	QFLB1HJ-473	0.047MF 50V MYLAR CAP.	
	C140	QFLB1HJ-473	0.047MF 50V MYLAR CAP.	
	C141	QCC21EM-473	0.047MF 25V CER. CAP.	
	C143	QCHB1EZ-223	0.022MF 25V CER. CAP.	
	C144	QCC21EM-473	0.047MF 25V CER. CAP.	
	C146	QETN1HM-105Z	1MF 50V AL E. CAP.	
	C147	QETN1HM-105Z	1MF 50V AL E. CAP.	
	C148	QETN1HM-474Z	0.47MF 50V AL E. CAP.	
	C149	QETN1HM-105Z	1MF 50V AL E. CAP.	
	C150	QETN1EM-226Z	22MF 25V E. CAP.	
	C156	QCHB1EZ-223	0.022MF 25V CER. CAP.	
	C157	QCC21EM-473	0.047MF 25V CER. CAP.	
	C158	QETN1EM-226Z	22MF 25V E. CAP.	
	C161	QETN1HM-105Z	1MF 50V AL E. CAP.	
	C162	QETN1HM-105Z	1MF 50V AL E. CAP.	
	C163	QCHB1EZ-223	0.022MF 25V CER. CAP.	
	C164	QCC21EM-473	0.047MF 25V CER. CAP.	
	C168	QFV81HJ-274	0.27MF 50V THIN FILM CAP.	
	C180	QETN1EM-107Z	100MF 25V E. CAP.	
	C181	QFLB1HJ-562	5600PF 50V MYLAR CAP.	
	C182	QFLB1HJ-562	5600PF 50V MYLAR CAP.	
	C183	QCHB1EZ-223	0.022MF 25V CER. CAP.	
	C184	QETN1EM-107Z	100MF 25V E. CAP.	
	C185	QETN1HM-105Z	1MF 50V AL E. CAP.	
	C186	QETN1HM-105Z	1MF 50V AL E. CAP.	
	C191	QCSB1HK-820Y	82PF 50V CER. CAP.	
	C192	QCSB1HJ-470	47PF 50V CER. CAP.	
	C193	QCB1HK-561Y	560PF 50V CER. CAP.	
	C194	QCHB1EZ-223	0.022MF 25V CER. CAP.	

△	Item	Parts Number	Description	Area
	C195	QCB1HK-331Y	330PF 50V CER. CAP.	
	C196	QETN1EM-226Z	22MF 25V E. CAP.	
	C197	QCZ0205-155	1.5MF 25V C. CAP.	
	C199	QETN1EM-226Z	22MF 25V E. CAP.	
		RESISTORS		
	R102	QRD167J-332	3.3K 1/6W CARBON RES.	
	R103	QRD161J-221	220 1/6W CARBON RES.	
	R104	QRD167J-272	2.7K 1/6W CARBON RES.	
	R105	QRD161J-391	390 1/6W CARBON RES.	
	R106	QRD161J-102	1K 1/6W CARBON RES.	
	R107	QRD161J-561	560 1/6W CARBON RES.	
	R108	QRD167J-332	3.3K 1/6W CARBON RES.	
	R109	QRD161J-221	220 1/6W CARBON RES.	
	R110	QRD161J-472	4.7K 1/6W CARBON RES.	
	R111	QRD161J-472	4.7K 1/6W CARBON RES.	
	R112	QRD161J-472	4.7K 1/6W CARBON RES.	
	R113	QRD161J-103	10K 1/6W CARBON RES.	
	R114	QRD161J-122	1.2K 1/6W CARBON RES.	
	R115	QRD161J-104	100K 1/6W CARBON RES.	
	R116	QRD161J-472	4.7K 1/6W CARBON RES.	
	R119	QRD161J-103	10K 1/6W CARBON RES.	
	R121	QRD161J-473	47K 1/6W CARBON RES.	
	R122	QRD161J-472	4.7K 1/6W CARBON RES.	
	R124	QRD161J-222	2.2K 1/6W CARBON RES.	
	R126	QRD167J-562	5.6K 1/6W CARBON RES.	
	R127	QRD167J-822	8.2K 1/6W CARBON RES.	
	R128	QRD161J-472	4.7K 1/6W CARBON RES.	
	R129	QRD161J-222	2.2K 1/6W CARBON RES.	
△	R130	QRZ0077-680	68 1/4W FUSIBLE RES.	
	R131	QRD161J-103	10K 1/6W CARBON RES.	
	R132	QRD161J-102	1K 1/6W CARBON RES.	
	R133	QRD167J-822	8.2K 1/6W CARBON RES.	
	R134	QRD161J-102	1K 1/6W CARBON RES.	
	R140	QRD161J-563	56K 1/6W CARBON RES.	
	R141	QRD161J-472	4.7K 1/6W CARBON RES.	
	R142	QRD161J-470	47 1/6W CARBON RES.	
	R143	QRD167J-562	5.6K 1/6W CARBON RES.	
	R144	QRD167J-332	3.3K 1/6W CARBON RES.	
	R145	QRD161J-103	10K 1/6W CARBON RES.	
	R146	QRD167J-562	5.6K 1/6W CARBON RES.	
	R147	QRD161J-273	27K 1/6W CARBON RES.	
	R148	QRD161J-561	560 1/6W CARBON RES.	
	R150	QRD161J-101	100 1/6W CARBON RES.	
	R157	QRD161J-182	1.8K 1/6W CARBON RES.	
	R158	QRD161J-182	1.8K 1/6W CARBON RES.	
	R161	QRD161J-102	1K 1/6W CARBON RES.	
	R162	QRD161J-102	1K 1/6W CARBON RES.	
	R163	QRD161J-472	4.7K 1/6W CARBON RES.	
	R164	QRD161J-472	4.7K 1/6W CARBON RES.	
	R181	QRD161J-102	1K 1/6W CARBON RES.	
	R182	QRD161J-103	10K 1/6W CARBON RES.	
	R183	QRD161J-103	10K 1/6W CARBON RES.	
	R184	QRD161J-103	10K 1/6W CARBON RES.	
	R191	QRD161J-222	2.2K 1/6W CARBON RES.	
		OTHERS		
		EMW10684-002	PRINTED BOARD	
		EMW10684-003	PRINTED BOARD	
	L111	EQL4007-150T	INDUCTOR	
	T111	EQR7121-006	RF COIL	
	T141	QOR0613-001	I. F. TRANSFORMER	
	T142	QAX0303-001	CERAMIC FILTER	
	X121	ECX0007-200KWJ1	CRYSTAL	
	X191	VCX5057-001	CRYSTAL	
	X192	EFO-EC4004T4	CERAMIC RESONATOR	
	AT101	EMB41YV-302K	ANTENNA TERMINAL	
	BK001	E308963-002	SHIELD BRACKET	
		E308963-223SM	SHIELD BRACKET	
	CF101	QAX0285-001Z	CERAMIC FILTER	
	CF102	QAX0285-001Z	CERAMIC FILTER	
	CN111	EMV5163-012R	CONNECT TERMINAL	
	CN112	EMV5109-005A	MALE CONNECTOR	
	FL141	EQF0101-013	LOWPASS FILTER	
	FL142	EQF0101-013	LOWPASS FILTER	
	RF101	QAU0005-001	FRONT END	

■ Electric Parts List (Tuner P. W. B)

△	Item	Parts Number	Description	Area
		I. C. S		
	IC102	LA1837	I. C (MONO-ANALOG)	
	IC121	LC72131	I. C (M)	
	IC191	LG7073	I. C (DIGI-MOS)	
	IC192	SAA6579	I. C (M)	
		DIODES		
	D121	1SS133	SI. DIODE	
	D123	1SS133	SI. DIODE	
	D129	1SS133	SI. DIODE	
	D130	MTZ10JC	ZENER DIODE	
	D131	1SS133	SI. DIODE	
		TRANSISTORS		
	Q101	2SC461	SI. TRANSISTOR	
	Q102	2SC535	SI. TRANSISTOR	
	Q103	2SC461	SI. TRANSISTOR	
	Q111	2SD2144S (VW)	SI. TRANSISTOR	
	Q112	2SD2144S (VW)	SI. TRANSISTOR	
	Q113	2SD2144S (VW)	SI. TRANSISTOR	
	Q114	2SD2144S (VW)	SI. TRANSISTOR	
	Q121	DTA124ES	DIGITAL TRANSISTOR	
	Q123	2SC2060 (Q, R)	SI. TRANSISTOR	
		CAPACITORS		
	C101	QCVB1CM-103Y	0.01MF 16V CER. CAP.	
	C102	QETN1EM-107Z	100MF 25V E. CAP.	
	C103	QCHB1EZ-223	0.022MF 25V CER. CAP.	
	C104	QCHB1EZ-223	0.022MF 25V CER. CAP.	
	C105	QCHB1EZ-223	0.022MF 25V CER. CAP.	
	C107	QETN1EM-226Z	22MF 25V E. CAP.	
	C109	QETN1EM-226Z	22MF 25V E. CAP.	
	C111	QCHB1EZ-223	0.022MF 25V CER. CAP.	
	C112	QCT30CH-120Y	12PF 50V CER. CAP.	
	C113	QCHB1EZ-223	0.022MF 25V CER. CAP.	
	C117	QCSB1HK-5R6Y	5.6PF 50V CER. CAP.	
	C118	QCSB1HJ-150Y	15PF 50V CER. CAP.	
	C121	QCT30CH-180Y	18PF 50V CER. CAP.	
	C122	QCT30CH-180Y	18PF 50V CER. CAP.	
	C123	QCC21EM-473	0.047MF 25V CER. CAP.	
	C126	QCBB1HK-101Y	100PF 50V CER. CAP.	
	C128	QENB1HM-474	0.47MF 50V NP E. CAP.	
	C129	QCGB1HK-102	1000PF 50V CER. CAP.	
	C130	QETN1EM-107Z	100MF 25V E. CAP.	
	C133	QETN1EM-226Z	22MF 25V E. CAP.	
	C134	QCBB1HK-331Y	330PF 50V CER. CAP.	
	C135	QCHB1EZ-223	0.022MF 25V CER. CAP.	
	C136	QETN1HM-105Z	1MF 50V AL E. CAP.	
	C137	QCBB1HK-391Y	390PF 50V CER. CAP.	
	C139	QFLB1HJ-473	0.047MF 50V MYLAR CAP.	
	C140	QFLB1HJ-473	0.047MF 50V MYLAR CAP.	
	C141	QCC21EM-473	0.047MF 25V CER. CAP.	
	C143	QCHB1EZ-223	0.022MF 25V CER. CAP.	
	C144	QCC21EM-473	0.047MF 25V CER. CAP.	
	C146	QETN1HM-105Z	1MF 50V AL E. CAP.	
	C147	QETN1HM-105Z	1MF 50V AL E. CAP.	
	C148	QETN1HM-474Z	0.47MF 50V AL E. CAP.	
	C149	QETN1HM-105Z	1MF 50V AL E. CAP.	
	C150	QETN1EM-226Z	22MF 25V E. CAP.	
	C156	QCHB1EZ-223	0.022MF 25V CER. CAP.	
	C157	QCC21EM-473	0.047MF 25V CER. CAP.	
	C158	QETN1EM-226Z	22MF 25V E. CAP.	
	C161	QETN1HM-105Z	1MF 50V AL E. CAP.	
	C162	QETN1HM-105Z	1MF 50V AL E. CAP.	
	C163	QCHB1EZ-223	0.022MF 25V CER. CAP.	
	C164	QCC21EM-473	0.047MF 25V CER. CAP.	
	C168	QFV81HJ-274	0.27MF 50V THIN FILM CAP.	
	C180	QETN1EM-107Z	100MF 25V E. CAP.	
	C181	QFLB1HJ-562	5600PF 50V MYLAR CAP.	
	C182	QFLB1HJ-562	5600PF 50V MYLAR CAP.	
	C183	QCHB1EZ-223	0.022MF 25V CER. CAP.	
	C184	QETN1EM-107Z	100MF 25V E. CAP.	
	C185	QETN1HM-105Z	1MF 50V AL E. CAP.	
	C186	QETN1HM-105Z	1MF 50V AL E. CAP.	
	C191	QCBB1HK-820Y	82PF 50V CER. CAP.	
	C192	QCSB1HJ-470	47PF 50V CER. CAP.	
	C193	QCBB1HK-561Y	560PF 50V CER. CAP.	
	C194	QCHB1EZ-223	0.022MF 25V CER. CAP.	

△	Item	Parts Number	Description	Area
	C195	QCBB1HK-331Y	330PF 50V CER. CAP.	
	C196	QETN1EM-226Z	22MF 25V E. CAP.	
	C197	QCZ0205-155	1.5MF 25V C. CAP.	
	C199	QETN1EM-226Z	22MF 25V E. CAP.	
		RESISTORS		
	R102	QRD167J-332	3.3K 1/6W CARBON RES.	
	R103	QRD161J-221	220 1/6W CARBON RES.	
	R104	QRD167J-272	2.7K 1/6W CARBON RES.	
	R105	QRD161J-391	390 1/6W CARBON RES.	
	R106	QRD161J-102	1K 1/6W CARBON RES.	
	R107	QRD161J-561	560 1/6W CARBON RES.	
	R108	QRD167J-332	3.3K 1/6W CARBON RES.	
	R109	QRD161J-221	220 1/6W CARBON RES.	
	R110	QRD161J-472	4.7K 1/6W CARBON RES.	
	R111	QRD161J-472	4.7K 1/6W CARBON RES.	
	R112	QRD161J-472	4.7K 1/6W CARBON RES.	
	R113	QRD161J-103	10K 1/6W CARBON RES.	
	R114	QRD161J-122	1.2K 1/6W CARBON RES.	
	R115	QRD161J-104	100K 1/6W CARBON RES.	
	R116	QRD161J-472	4.7K 1/6W CARBON RES.	
	R119	QRD161J-103	10K 1/6W CARBON RES.	
	R121	QRD161J-473	47K 1/6W CARBON RES.	
	R122	QRD161J-472	4.7K 1/6W CARBON RES.	
	R124	QRD161J-222	2.2K 1/6W CARBON RES.	
	R126	QRD167J-562	5.6K 1/6W CARBON RES.	
	R127	QRD167J-822	8.2K 1/6W CARBON RES.	
	R128	QRD161J-472	4.7K 1/6W CARBON RES.	
	R129	QRD161J-222	2.2K 1/6W CARBON RES.	
△	R130	QRZ0077-680	68 1/4W FUSIBLE RES.	
	R131	QRD161J-103	10K 1/6W CARBON RES.	
	R132	QRD161J-102	1K 1/6W CARBON RES.	
	R133	QRD167J-822	8.2K 1/6W CARBON RES.	
	R134	QRD161J-102	1K 1/6W CARBON RES.	
	R140	QRD161J-563	56K 1/6W CARBON RES.	
	R141	QRD161J-472	4.7K 1/6W CARBON RES.	
	R142	QRD161J-470	47 1/6W CARBON RES.	
	R143	QRD167J-562	5.6K 1/6W CARBON RES.	
	R144	QRD167J-332	3.3K 1/6W CARBON RES.	
	R145	QRD161J-103	10K 1/6W CARBON RES.	
	R146	QRD167J-562	5.6K 1/6W CARBON RES.	
	R147	QRD161J-273	27K 1/6W CARBON RES.	
	R148	QRD161J-561	560 1/6W CARBON RES.	
	R150	QRD161J-101	100 1/6W CARBON RES.	
	R157	QRD161J-182	1.8K 1/6W CARBON RES.	
	R158	QRD161J-182	1.8K 1/6W CARBON RES.	
	R161	QRD161J-102	1K 1/6W CARBON RES.	
	R162	QRD161J-102	1K 1/6W CARBON RES.	
	R163	QRD161J-472	4.7K 1/6W CARBON RES.	
	R164	QRD161J-472	4.7K 1/6W CARBON RES.	
	R181	QRD161J-102	1K 1/6W CARBON RES.	
	R182	QRD161J-103	10K 1/6W CARBON RES.	
	R183	QRD161J-103	10K 1/6W CARBON RES.	
	R184	QRD161J-103	10K 1/6W CARBON RES.	
	R191	QRD161J-222	2.2K 1/6W CARBON RES.	
		OTHERS		
		EMW10684-002	PRINTED BOARD	
		EMW10684-003	PRINTED BOARD	
	L111	EQL4007-150T	INDUCTOR	
	T111	EQR7121-006	RF COIL	
	T141	QOR0613-001	I. F. TRANSFORMER	
	T142	QAX0303-001	CERAMIC FILTER	
	X121	ECX0007-200KWJ1	CRYSTAL	
	X191	VCX5057-001	CRYSTAL	
	X192	EFO-EC4004T4	CERAMIC RESONATOR	
	AT101	EMB41YV-302K	ANTENNA TERMINAL	
	BK001	E308963-002	SHIELD BRACKET	
		E308963-223SM	SHIELD BRACKET	
	CF101	QAX0285-001Z	CERAMIC FILTER	
	CF102	QAX0285-001Z	CERAMIC FILTER	
	CN111	EMV5163-012R	CONNECT TERMINAL	
	CN112	EMV5109-005A	MALE CONNECTOR	
	FL141	EQF0101-013	LOWPASS FILTER	
	FL142	EQF0101-013	LOWPASS FILTER	
	RF101	GAU0005-001	FRONT END	

■ Electric Parts List (Power Amp P. W. B.)

△	Item	Parts Number	Description	Area	△	Item	Parts Number	Description	Area
		I. C. S							
	IC501	BU4051BC	I. C (DIGI-MOS)			Q720	2SA1038 (R. S)	SI. TRANSISTOR	
	IC511	BA15218N	I. C (MONO-ANALOG)			Q721	2SD636	SI. TRANSISTOR	
	IC901	TA7317P	I. C (MONO-ANALOG)			Q722	2SD636	SI. TRANSISTOR	
		DIODES				Q723	2SC2389 (S. E)	SI. TRANSISTOR	
	D010	1SS133	SI. DIODE			Q724	2SC2389 (S. E)	SI. TRANSISTOR	
	D011	MTZ18JC	ZENER DIODE			Q725	2SA1038 (R. S)	SI. TRANSISTOR	
	D012	1SS133	SI. DIODE			Q726	2SA1038 (R. S)	SI. TRANSISTOR	
	D013	1SS133	SI. DIODE			Q727	2SC2235 (O. Y)	SI. TRANSISTOR	
	D014	1SS133	SI. DIODE			Q728	2SC2235 (O. Y)	SI. TRANSISTOR	
	D015	1SS133	SI. DIODE			Q729	2SA965 (Y)	SI. TRANSISTOR	
	D021	1SS133	SI. DIODE			Q730	2SA965 (Y)	SI. TRANSISTOR	
	D022	1SS133	SI. DIODE			Q801	2SB1187 (F. G)	SI. TRANSISTOR	
	D482	1SS133	SI. DIODE			Q803	2SD2061 (F. G)	SI. TRANSISTOR	
	D483	1SS133	SI. DIODE			Q804	2SD2061 (F. G)	SI. TRANSISTOR	
	D484	MTZ6. 2JC	ZENER DIODE			Q805	2SD2061 (F. G)	SI. TRANSISTOR	
	D520	MTZ5. 1JC	ZENER DIODE			Q806	2SC2235 (O. Y)	SI. TRANSISTOR	
	D521	MTZ5. 1JC	ZENER DIODE			Q901	2SC2389 (S. E)	SI. TRANSISTOR	
	D701	1SS133	SI. DIODE			Q902	2SC2389 (S. E)	SI. TRANSISTOR	
	D702	1SS133	SI. DIODE			Q903	2SA1038 (R. S)	SI. TRANSISTOR	
	D703	1SS133	SI. DIODE			Q904	2SK301 (P. Q)	F. E. T.	
	D704	1SS133	SI. DIODE			Q905	DTA144ES	DIGITAL TRANSISTOR	
	D705	MTZ18JC	ZENER DIODE			Q906	DTC114YS	DIGITAL TRANSISTOR	
	D709	1SS133	SI. DIODE			Q907	2SD2144S (VW)	SI. TRANSISTOR	
	D710	1SS133	SI. DIODE				CAPACITORS		
	D711	1SS133	SI. DIODE			C010	QCF21HP-223A	0. 022MF 50V CER. CAP.	
	D712	1SS133	SI. DIODE			C011	QETB1HM-106	10MF 50V E. CAP.	
	D811	1SS133	SI. DIODE			C012	QCS21HJ-470	47PF 50V CER. CAP.	
	D812	MTZ15JC	ZENER DIODE			C013	QETB1EM-106	10MF 25V AL. E. CAP.	
	D813	1SS133	SI. DIODE			C014	QCS21HJ-101A	100PF 50V CER. CAP.	
	D814	MTZ6. 8JC	ZENER DIODE			C015	QCS21HJ-5R0	5PF 50V CER. CAP.	
	D815	1SS133	SI. DIODE			C016	QETB1CM-476	47MF 16V AL. E. CAP.	
	D816	MTZ15JC	ZENER DIODE			C017	QCS22HJ-330	33PF 500V CER. CAP.	
	D817	1SS133	SI. DIODE			C018	QFLB1HJ-103	0. 01MF 50V MYLAR CAP.	
	D818	1SS133	SI. DIODE			C019	QETB1HM-476	47MF 50V E. CAP.	
	D819	MTZ13JC	ZENER DIODE			C020	QCS22HJ-470A	47PF 500V CER. CAP.	
	D820	MTZ5. 1JC	ZENER DIODE			C021	QETB1HM-225	2. 2MF 50V AL. E. CAP.	
	D821	MTZ10JC	ZENER DIODE			C023	QCS22HJ-470A	47PF 500V CER. CAP.	
	D901	1SS133	SI. DIODE			C024	QFLB1HJ-473	0. 047MF 50V MYLAR CAP.	
	D902	1SS133	SI. DIODE			C025	QFLB1HJ-473	0. 047MF 50V MYLAR CAP.	
	D903	1SS133	SI. DIODE			C026	QCF21HP-223A	0. 022MF 50V CER. CAP.	
		TRANSISTORS				C027	QCY31HK-332Z	3300PF 50V CER. CAP.	
	Q011	2SC2240 (GR. BL)	SI. TRANSISTOR			C028	QCY31HK-332Z	3300PF 50V CER. CAP.	
	Q012	2SC2240 (GR. BL)	SI. TRANSISTOR			C064	QFLB1HJ-473	0. 047MF 50V MYLAR CAP.	
	Q013	2SA1038 (R. S)	SI. TRANSISTOR			C065	QFLB1HJ-473	0. 047MF 50V MYLAR CAP.	
	Q015	2SC2235 (O. Y)	SI. TRANSISTOR			C061	QFLB1HJ-223	0. 022MF 50V MYLAR CAP.	
	Q017	2SA965 (Y)	SI. TRANSISTOR			C082	QCF21HP-222	2200PF 50V CER. CAP.	
	Q019	2SC1775AV (F1)	SI. TRANSISTOR			C083	QCS21HJ-101A	100PF 50V CER. CAP.	
	Q020	DTC123YS	DIGITAL TRANSISTOR			C084	QFLB1HJ-223	0. 022MF 50V MYLAR CAP.	
	Q021	2SC2389 (S. E)	SI. TRANSISTOR			C091	QCF21HP-222	2200PF 50V CER. CAP.	
	Q022	2SA1038 (R. S)	SI. TRANSISTOR			C092	QCS21HJ-101A	100PF 50V CER. CAP.	
	Q701	2SC1775AV (F1)	SI. TRANSISTOR			C093	QCS21HJ-101A	100PF 50V CER. CAP.	
	Q702	2SC1775AV (F1)	SI. TRANSISTOR			C094	QCF21HP-223A	0. 022MF 50V CER. CAP.	
	Q703	2SC1775AV (F1)	SI. TRANSISTOR			C095	QFLB1HJ-223	0. 022MF 50V MYLAR CAP.	
	Q704	2SC1775AV (F1)	SI. TRANSISTOR			C096	QFLB1HJ-473	0. 047MF 50V MYLAR CAP.	
	Q705	2SA1038 (R. S)	SI. TRANSISTOR			C481	QCB1HK-331Y	330PF 50V CER. CAP.	
	Q706	2SA1038 (R. S)	SI. TRANSISTOR			C482	QCHB1EZ-223	0. 022MF 25V CER. CAP.	
	Q707	2SA933LN (R. S)	SI. TRANSISTOR			C521	QETB1HM-106	10MF 50V E. CAP.	
	Q708	2SA933LN (R. S)	SI. TRANSISTOR			C522	QCF21HP-103A	0. 01MF 50V CER. CAP.	
	Q709	2SA1038 (R. S)	SI. TRANSISTOR			C523	QFLB1HJ-123	0. 012MF 50V MYLAR CAP.	
	Q710	2SA1038 (R. S)	SI. TRANSISTOR			C524	QETB1HM-106	10MF 50V E. CAP.	
	Q711	2SC2389 (S. E)	SI. TRANSISTOR			C525	QCB1HK-101Y	100PF 50V CER. CAP.	
	Q712	2SC2389 (S. E)	SI. TRANSISTOR			C528	QETC1AM-476ZM	47MF 10V E. CAP.	
	Q717	2SC2389 (S. E)	SI. TRANSISTOR			C529	QETC1AM-476ZM	47MF 10V E. CAP.	
	Q718	2SC2389 (S. E)	SI. TRANSISTOR			C701	QETB1HM-106	10MF 50V E. CAP.	
	Q719	2SA1038 (R. S)	SI. TRANSISTOR			C702	QETB1HM-106	10MF 50V E. CAP.	
						C703	QCS21HJ-271A	270PF 50V CER. CAP.	

■ Electric Parts List (Power Amp P. W. B.)

△	Item	Parts Number	Description	Area
	C704	QCS21HJ-271A	270PF 50V CER. CAP.	
	C705	QCS21HJ-101A	100PF 50V CER. CAP.	
	C706	QCS21HJ-101A	100PF 50V CER. CAP.	
	C707	QETB1CM-476	47MF 16V AL. E. CAP.	
	C708	QETB1CM-476	47MF 16V AL. E. CAP.	
	C709	QCS21HJ-100	10PF 50V CER. CAP.	
	C710	QCS21HJ-100	10PF 50V CER. CAP.	
	C711	QCY31HK-152Z	1500PF 50V CER. CAP.	
	C712	QCY31HK-152Z	1500PF 50V CER. CAP.	
	C713	QCS21HJ-680A	68PF 50V CER. CAP.	
	C714	QCS21HJ-680A	68PF 50V CER. CAP.	
	C715	QCS21HJ-680A	68PF 50V CER. CAP.	
	C716	QCS21HJ-680A	68PF 50V CER. CAP.	
	C717	QCS22HJ-220	22PF 500V CER. CAP.	
	C718	QCS22HJ-220	22PF 500V CER. CAP.	
	C719	QFLB1HJ-472	4700PF 50V MYLAR CAP.	
	C720	QFLB1HJ-472	4700PF 50V MYLAR CAP.	
	C722	QETB1EM-476	47MF 25V AL. E. CAP.	
	C723	QETB2AM-476	47MF 100V AL. E. CAP.	
	C724	QETB2AM-476	47MF 100V AL. E. CAP.	
	C725	QCS22HJ-470A	47PF 500V CER. CAP.	
	C726	QCS22HJ-470A	47PF 500V CER. CAP.	
	C727	QCS22HJ-470A	47PF 500V CER. CAP.	
	C728	QCS22HJ-470A	47PF 500V CER. CAP.	
	C729	QFLB1HJ-473	0.047MF 50V MYLAR CAP.	
	C730	QFLB1HJ-473	0.047MF 50V MYLAR CAP.	
	C731	QFLB1HJ-473	0.047MF 50V MYLAR CAP.	
	C732	QFLB1HJ-473	0.047MF 50V MYLAR CAP.	
	C733	QCF21HP-472	4700PF 50V CER. CAP.	
	C734	QCF21HP-472	4700PF 50V CER. CAP.	
	C735	QCF21HP-472	4700PF 50V CER. CAP.	
	C736	QCF21HP-472	4700PF 50V CER. CAP.	
	C801	EEW7103-109T	10000MF AL. E. CAP.	
		EEW7504-109T	10000MF E. CAP.	
	C802	EEW7103-109T	10000MF AL. E. CAP.	
		EEW7504-109T	10000MF E. CAP.	
	C812	QETB1EM-107	100MF 25V AL. E. CAP.	
	C814	QETB1EM-107	100MF 25V AL. E. CAP.	
	C816	QETB1EM-107	100MF 25V AL. E. CAP.	
	C819	QETB1EM-107	100MF 25V AL. E. CAP.	
	C820	QETB1EM-107	100MF 25V AL. E. CAP.	
	C822	QETB1EM-476	47MF 50V E. CAP.	
	C823	QETB1EM-476	47MF 50V E. CAP.	
	C871	QCZ0205-155	1.5MF 25V C. CAP.	
	C901	QCF21HP-223A	0.022MF 50V CER. CAP.	
	C902	QCF21HP-223A	0.022MF 50V CER. CAP.	
	C903	QETB1EM-226E	22MF 50V E. CAP.	
	C904	QCF21HP-103A	0.01MF 50V CER. CAP.	
	C905	QCY31HK-102Z	1000PF 50V CER. CAP.	
	C906	QETC1AM-476ZM	47MF 10V E. CAP.	
	C909	QETB1CM-226	22MF 16V E. CAP.	
	C965	QCBB1HK-151	150PF 50V CER. CAP.	
	C966	QCBB1HK-151	150PF 50V CER. CAP.	
	C967	QCBB1HK-151	150PF 50V CER. CAP.	
	C968	QCBB1HK-151	150PF 50V CER. CAP.	
	C971	QCBB1HK-391Y	390PF 50V CER. CAP.	
	C972	QCBB1HK-391Y	390PF 50V CER. CAP.	
	C973	QCS31HJ-471Z	470PF 50V CER. CAP.	
	C974	QCS31HJ-471Z	470PF 50V CER. CAP.	
	C975	QFLB1HJ-473	0.047MF 50V MYLAR CAP.	
	C976	QFLB1HJ-473	0.047MF 50V MYLAR CAP.	
	C977	QFLB1HJ-473	0.047MF 50V MYLAR CAP.	
	C978	QFLB1HJ-473	0.047MF 50V MYLAR CAP.	
	C979	QCS31HJ-331Z	330PF 50V CER. CAP.	
	C980	QCS31HJ-331Z	330PF 50V CER. CAP.	
		RESISTORS		

△	Item	Parts Number	Description	Area
	R011	QRD161J-222	2.2K 1/6W CARBON RES.	
	R012	QRD161J-104	100K 1/6W CARBON RES.	
	R013	QRD161J-123	12K 1/6W CARBON RES.	
	R014	QRD161J-162	1.6K 1/6W CARBON RES.	
	R015	QRD161J-104	100K 1/6W CARBON RES.	
△	R016	QRD14CJ-181S	180 1/4W UNF. CARBON R	
△	R017	QRD14CJ-332SX	3.3K 1/4W UNF. CARBON R	
	R018	QRD167J-332	3.3K 1/6W CARBON RES.	
	R019	QRD167J-332	3.3K 1/6W CARBON RES.	
	R020	QRD167J-332	3.3K 1/6W CARBON RES.	
△	R023	QRD14CJ-100SX	10 1/4W UNF. CARBON R	
△	R024	QRD14CJ-100SX	10 1/4W UNF. CARBON R	
△		QRD14CJ-220S	22 1/4W UNF. CARBON R	
△	R025	QRD14CJ-561SX	560 1/4W UNF. CARBON R	
△	R026	QRD14CJ-100SX	10 1/4W UNF. CARBON R	
△		QRD14CJ-220S	22 1/4W UNF. CARBON R	
△	R027	QRD14CJ-100SX	10 1/4W UNF. CARBON R	
	R028	QRD161J-391	390 1/6W CARBON RES.	
	R029	ERT-D2WHL202S	2K 1/4W NEGATIVE THE	
	R030	QRD161J-183	18K 1/6W CARBON RES.	
	R031	QRD161J-123	12K 1/6W CARBON RES.	
△	R032	QRD125J-330	33 1/2W UNF. CARBON R	
△	R033	QRG022J-100A	10 2W OXIDE METAL	
	R034	QRD161J-104	100K 1/6W CARBON RES.	
△	R035	QRD14CJ-221S	220 1/4W UNF. CARBON R	
△		QRD14CJ-471SX	470 1/4W UNF. CARBON R	
△	R036	QRD14CJ-221S	220 1/4W UNF. CARBON R	
△		QRD14CJ-471SX	470 1/4W UNF. CARBON R	
△	R037	QRG022J-562A	5.6K 2W OXIDE METAL	
	R038	QRD167J-751	750 1/6W CARBON RES.	
△	R039	QRD14CJ-100SX	10 1/4W UNF. CARBON R	
	R040	QRD161J-3R3	3.3 1/6W CARBON RES.	
	R043	QRD161J-102	1K 1/6W CARBON RES.	
	R045	QRD167J-151	150 1/6W CARBON RES.	
	R046	QRD167J-151	150 1/6W CARBON RES.	
	R047	QRD167J-151	150 1/6W CARBON RES.	
	R048	QRD167J-151	150 1/6W CARBON RES.	
△	R073	QRG022J-100A	10 2W OXIDE METAL	
	R074	QRD161J-104	100K 1/6W CARBON RES.	
△	R081	QRZ0077-4R7	4.7 1/4W FUSE RESISTO	
△	R091	QRZ0077-4R7	4.7 1/4W FUSE RESISTO	
△	R092	QRZ0077-100	10 1/4W FUSIBLE RES.	
	R481	QRD161J-100	10 1/6W CARBON RES.	
	R482	QRD161J-102	1K 1/6W CARBON RES.	
	R521	QRD161J-752	7.5K 1/6W CARBON RES.	
	R522	QRD161J-103	10K 1/6W CARBON RES.	
	R523	QRD161J-103	10K 1/6W CARBON RES.	
	R524	QRD167J-682	6.8K 1/6W CARBON RES.	
	R525	QRD161J-182	1.8K 1/6W CARBON RES.	
	R526	QRD161J-132	1.3K 1/6W CARBON RES.	
	R527	QRD161J-104	100K 1/6W CARBON RES.	
△	R529	QRZ0077-680	68 1/4W FUSIBLE RES.	
△	R530	QRZ0077-680	68 1/4W FUSIBLE RES.	
△	R531	QRD14CJ-681SX	680 1/4W UNF. CARBON R	
△		QRZ0077-681	680 1/4W FUSIBLE RES.	
△	R532	QRD14CJ-681SX	680 1/4W UNF. CARBON R	
△		QRZ0077-681	680 1/4W FUSIBLE RES.	
	R533	QRD161J-273	27K 1/6W CARBON RES.	
	R534	QRD161J-203	20K 1/6W CARBON RES.	
	R535	QRD161J-104	100K 1/6W CARBON RES.	
	R536	QRD167J-223	22K 1/6W CARBON RES.	
	R701	QRD161J-222	2.2K 1/6W CARBON RES.	
	R702	QRD161J-222	2.2K 1/6W CARBON RES.	
	R703	QRD161J-104	100K 1/6W CARBON RES.	
	R704	QRD161J-104	100K 1/6W CARBON RES.	
	R705	QRD161J-202	2K 1/6W CARBON RES.	

■ Electric Parts List (Power Amp P. W. B.)

△	Item	Parts Number	Description	Area	△	Item	Parts Number	Description	Area
	R706	QRD161J-202	2K 1/6W CARBON RES.			R788	QRD161J-103	10K 1/6W CARBON RES.	
	R707	QRD161J-202	2K 1/6W CARBON RES.			R789	QRD161J-473	47K 1/6W CARBON RES.	
	R708	QRD161J-202	2K 1/6W CARBON RES.			R799	QRZ0197-R22	0.22 1W NETWORK RES.	
	R709	QRD167J-822	8.2K 1/6W CARBON RES.			R801	QRD161J-104	100K 1/6W CARBON RES.	
	R710	QRD167J-822	8.2K 1/6W CARBON RES.			R802	QRD161J-104	100K 1/6W CARBON RES.	
	R711	QRD161J-821	820 1/6W CARBON RES.		△	R811	QRD14CJ-120SX	12 1/4W UNF. CARBON R	
	R712	QRD161J-821	820 1/6W CARBON RES.		△	R813	QRD14CJ-122SX	1.2K 1/4W UNF. CARBON R	
	R713	QRD161J-133Y	13K 1/6W CARBON RES.		△	R819	QRD14CJ-100SX	10 1/4W UNF. CARBON R	
	R714	QRD161J-133Y	13K 1/6W CARBON RES.		△		QRZ0077-100	10 1/4W FUSIBLE RES.	
	R715	QRD161J-823	82K 1/6W CARBON RES.		△	R822	QRD14CJ-272S	2.7K 1/4W UNF. CARBON R	
	R716	QRD161J-823	82K 1/6W CARBON RES.		△	R823	QRD14CJ-220S	22 1/4W UNF. CARBON R	
	R717	QRD12CJ-153SX	15K 1/2W UNF. CARBON R		△		QRZ0077-100	10 1/4W FUSIBLE RES.	
	R718	QRD12CJ-153SX	15K 1/2W UNF. CARBON R		△	R825	QRD14CJ-332SX	3.3K 1/4W UNF. CARBON R	
	R719	QRD161J-391	390 1/6W CARBON RES.		△	R826	QRD14CJ-120SX	12 1/4W UNF. CARBON R	
	R720	QRD161J-391	390 1/6W CARBON RES.				QRZ0077-120X	12 1/4W FUSIBLE RES.	
	R721	QRD14CJ-151SX	150 1/4W UNF. CARBON R			R828	QRD12CJ-153SX	15K 1/2W UNF. CARBON R	
	R722	QRD14CJ-151SX	150 1/4W UNF. CARBON R		△	R834	QRD14CJ-100SX	10 1/4W UNF. CARBON R	
	R723	QRD167J-152	1.5K 1/6W CARBON RES.		△		QRD14CJ-3R9S	3.9 1/4W UNF. CARBON R	
	R724	QRD167J-152	1.5K 1/6W CARBON RES.		△	R835	QRD12CJ-391S	390 1/2W UNF. CARBON R	
	R725	QRD161J-333	33K 1/6W CARBON RES.		△	R838	QRD12CJ-2R2SX	2.2 1/2W UNF. CARBON R	
	R726	QRD161J-333	33K 1/6W CARBON RES.		△	R843	QRD14CJ-100SX	10 1/4W UNF. CARBON R	
	R727	QRD161J-391	390 1/6W CARBON RES.			R850	QRD14CJ-331SX	330 1/4W UNF. CARBON R	
	R728	QRD161J-391	390 1/6W CARBON RES.		△	R851	QRZ0077-100	10 1/4W FUSIBLE RES.	
	R729	QRD161J-391	390 1/6W CARBON RES.			R863	QRD161J-102	1K 1/6W CARBON RES.	
	R730	QRD161J-391	390 1/6W CARBON RES.			R864	QRD161J-102	1K 1/6W CARBON RES.	
	R731	QRD161J-101	100 1/6W CARBON RES.			R901	QRD161J-102	1K 1/6W CARBON RES.	
	R732	QRD161J-101	100 1/6W CARBON RES.			R902	QRD161J-102	1K 1/6W CARBON RES.	
△	R733	QRD14CJ-100SX	10 1/4W UNF. CARBON R			R903	QRD167J-562	5.6K 1/6W CARBON RES.	
△	R734	QRD14CJ-100SX	10 1/4W UNF. CARBON R			R904	QRD167J-562	5.6K 1/6W CARBON RES.	
△	R735	QRG022J-562A	5.6K 2W OXIDE METAL			R905	QRD161J-123	12K 1/6W CARBON RES.	
	R739	QRD161J-221	220 1/6W CARBON RES.			R906	QRD161J-123	12K 1/6W CARBON RES.	
	R740	QRD161J-221	220 1/6W CARBON RES.			R907	QRD161J-102	1K 1/6W CARBON RES.	
	R741	QRD161J-221	220 1/6W CARBON RES.			R908	QRD161J-102	1K 1/6W CARBON RES.	
	R742	QRD161J-221	220 1/6W CARBON RES.			R909	QRD161J-103	10K 1/6W CARBON RES.	
	R751	QRD161J-361	360 1/6W CARBON RES.			R911	QRD167J-332	3.3K 1/6W CARBON RES.	
	R752	QRD161J-361	360 1/6W CARBON RES.			R912	QRD161J-473	47K 1/6W CARBON RES.	
	R753	QRD161J-361	360 1/6W CARBON RES.			R913	QRD161J-104	100K 1/6W CARBON RES.	
	R754	QRD161J-361	360 1/6W CARBON RES.			R914	QRD161J-823	82K 1/6W CARBON RES.	
	R755	QRD161J-132	1.3K 1/6W CARBON RES.			R915	QRD161J-823	82K 1/6W CARBON RES.	
	R756	QRD161J-132	1.3K 1/6W CARBON RES.			R916	QRD161J-563	56K 1/6W CARBON RES.	
	R761	QRD161J-391	390 1/6W CARBON RES.			R917	QRD161J-683	68K 1/6W CARBON RES.	
	R762	QRD161J-391	390 1/6W CARBON RES.			R918	QRD161J-392	3.9K 1/6W CARBON RES.	
	R763	ERT-D2WHL202S	2K 1/4W NEGATIVE THE			R921	QRD161J-224	220K 1/6W CARBON RES.	
	R764	ERT-D2WHL202S	2K 1/4W NEGATIVE THE			R922	QRD167J-562	5.6K 1/6W CARBON RES.	
△	R765	QRD14CJ-272S	2.7K 1/4W UNF. CARBON R		△	R929	QRD14CJ-470SX	47 1/4W UNF. CARBON R	
△	R766	QRD14CJ-272S	2.7K 1/4W UNF. CARBON R		△	R941	QRG022J-471A	470 2W OXIDE METAL	
△	R767	QRD14CJ-271S	270 1/4W UNF. CARBON R		△	R942	QRG022J-471A	470 2W OXIDE METAL	
△	R768	QRD14CJ-271S	270 1/4W UNF. CARBON R			R951	QRD161J-333	33K 1/6W CARBON RES.	
△	R769	QRD14CJ-100SX	10 1/4W UNF. CARBON R			R952	QRD161J-333	33K 1/6W CARBON RES.	
△	R770	QRD14CJ-100SX	10 1/4W UNF. CARBON R			R953	QRD161J-333	33K 1/6W CARBON RES.	
△	R771	QRD14CJ-100SX	10 1/4W UNF. CARBON R		△	R961	QRZ0077-100	10 1/4W FUSIBLE RES.	
△	R772	QRD14CJ-100SX	10 1/4W UNF. CARBON R		△	R962	QRZ0077-100	10 1/4W FUSIBLE RES.	
	R773	QRZ0197-R22	0.22 1W NETWORK RES.		△	R963	QRZ0077-100	10 1/4W FUSIBLE RES.	
	R774	QRZ0197-R22	0.22 1W NETWORK RES.		△	R964	QRZ0077-100	10 1/4W FUSIBLE RES.	
△	R775	QRD129J-470	47 1/2W UNF. CARBON R			R965	QRD161J-823	82K 1/6W CARBON RES.	
△	R776	QRD129J-470	47 1/2W UNF. CARBON R			R966	QRD161J-124	120K 1/6W CARBON RES.	
△	R777	QRG022J-100A	10 2W OXIDE METAL			R967	QRD161J-105	1M 1/6W CARBON RES.	
△	R778	QRG022J-100A	10 2W OXIDE METAL			R968	QRD161J-103	10K 1/6W CARBON RES.	
△	R779	QRD14CJ-100SX	10 1/4W UNF. CARBON R			R969	QRD161J-3R3	3.3 1/6W CARBON RES.	
△	R780	QRD14CJ-100SX	10 1/4W UNF. CARBON R			VR791	QVPA601-501A	500 TRIMMER RES.	
△	R781	QRD14CJ-100SX	10 1/4W UNF. CARBON R			VR792	QVPA601-501A	500 TRIMMER RES.	
△	R782	QRD14CJ-100SX	10 1/4W UNF. CARBON R				OTHERS		
△	R783	QRD14CJ-100SX	10 1/4W UNF. CARBON R				EMW10701-002	PRINTED BOARD	
△	R784	QRD14CJ-100SX	10 1/4W UNF. CARBON R				SBSG3008CC	TAPPING SCREW	
△	R785	QRD14CJ-100SX	10 1/4W UNF. CARBON R			J481	QMS3501-021	PIN JACK	
△	R786	QRD14CJ-100SX	10 1/4W UNF. CARBON R			J901	QMS6022-V01	MICROPHONE JACK	

RX-630RBK

■Electric Parts List (Power Amp P. W. B.)

△	Item	Parts Number	Description	Area
	L011	EQL0011-R45J1	INDUCTOR	
	L012	EQL0011-R45J1	INDUCTOR	
	L052	EQL0011-R45J1	INDUCTOR	
	L701	EQL0001-1R0	INDUCTOR	
	L702	EQL0001-1R0	INDUCTOR	
	L961	EQL0011-R45J1	INDUCTOR	
	L962	EQL0011-R45J1	INDUCTOR	
	L963	EQL0011-R45J1	INDUCTOR	
	L964	EQL0011-R45J1	INDUCTOR	
	S001	QST4241-E05J2	PUSH SWITCH	
	CN101	EMV7163-012	CONNECT TERMINAL	
	CN109	EWS293-0120	SOCKET WIRE	
	CN119	VMC0075-003	CONNECTOR	
	CN311	VMC0075-008N	CONNECT TERMINAL	
	CN411	VMC0163-021	CONNECT TERMINAL	
	CN501	EMV7163-011	CONNECT TERMINAL	
	CN601	EMV7163-007	CONNECT TERMINAL	
	CN602	EMV7163-011	CONNECT TERMINAL	
	CN701	EMV7163-006	CONNECT TERMINAL	
	CN801	EMV7163-007	CONNECT TERMINAL	
	CN812	EMV5129-003	CONNECTOR	
	CN813	VMC0178-003	CONNECT TERMINAL	
	CN814	VMC0178-003	CONNECT TERMINAL	
	EP001	EMZ4002-002Z	EARTH PLATE	
	EP003	EMZ4002-002Z	EARTH PLATE	
	EP004	EMZ4002-002Z	EARTH PLATE	
	EP005	EMZ4002-002Z	EARTH PLATE	
	EP006	EMZ4002-002Z	EARTH PLATE	
	EP007	EMZ4002-002Z	EARTH PLATE	
	FW901	EWK33D-08SS	FLAT WIRE	
	FW903	EWK36D-45SS	FLAT WIRE	
		EWS356-002	SOCKET WIRE ASSY	
	HS801	E70306-001	HEAT SINK	
	HS803	E70306-001	HEAT SINK	
	HS804	E70306-001	HEAT SINK	
	HS805	E70306-001	HEAT SINK	
	RY011	ESK7D24-2120	RELAY	
	RY901	ESK7D24-2120	RELAY	
	ST011	EMB90TV-801G	SPEAKER TERMINAL	
	ST901	EMB00TV-801B	TERMINAL	
	TP751	QMV5005-004K	PLUG ASSY	

■ Electric Parts List (Display Control P. W. B.)

△	Item	Parts Number	Description	Area	△	Item	Parts Number	Description	Area
		I. C. S					CAPACITORS		
	IC401	MN101C01DAC	I. C (MICRO-COMPUTER)			C001	QCZ9019-472	4700PF C. CAP.	
		MN101C01DAC1	I. C (M)		△	C002	QCZ9019-472	4700PF C. CAP.	
	IC402	GP1U271X	INFRARED DETECT UNIT			C050	QCHB1EZ-223	0.022MF 25V CER. CAP.	
	IC403	PST600E-T	I. C (MONO-ANALOG)			C051	QETB1HM-106	10MF 50V E. CAP.	
	IC411	MN171602JAAN	I. C (MICRO-COMPUTER)			C052	QCS31HJ-331Z	330PF 50V CER. CAP.	
		DIODES				C053	QETB1EM-106	10MF 25V AL E. CAP.	
	D050	1SS133	SI. DIODE			C054	QCS21HJ-101A	100PF 50V CER. CAP.	
	D051	MTZ18JC	ZENER DIODE			C055	QCS21HJ-5R0	5PF 50V CER. CAP.	
	D052	1SS133	SI. DIODE			C056	QETB1CM-476	47MF 16V AL E. CAP.	
	D053	1SS133	SI. DIODE			C057	QCS22HJ-330	33PF 500V CER. CAP.	
	D061	1SS133	SI. DIODE			C058	QFLB1HJ-103	0.01MF 50V MYLAR CAP.	
	D062	1SS133	SI. DIODE			C059	QETB1HM-476	47MF 50V E. CAP.	
	D292	1SS133	SI. DIODE			C060	QCS22HJ-470A	47PF 500V CER. CAP.	
	D404	1SS133	SI. DIODE			C061	QETB1HM-225	2.2MF 50V AL E. CAP.	
	D406	1SS133	SI. DIODE			C063	QCS22HJ-470A	47PF 500V CER. CAP.	
	D407	1SS133	SI. DIODE			C066	QCF21HP-223A	0.022MF 50V CER. CAP.	
	D415	1SR139-200	SI. DIODE			C067	QCY31HK-332Z	3300PF 50V CER. CAP.	
	D416	1SR139-200	SI. DIODE			C068	QCY31HK-332Z	3300PF 50V CER. CAP.	
	D417	1SR139-200	SI. DIODE			C291	QCS31HJ-471Z	470PF 50V CER. CAP.	
	D418	1SS133	SI. DIODE			C294	QCS31HJ-681Z	680PF 50V CER. CAP.	
	D419	1SS133	SI. DIODE			C401	QETB1AM-227	220MF 10V E. CAP.	
	D421	1SS133	SI. DIODE			C402	QCZ0202-155	1.5MF 25V CER. RES.	
	D425	SLR-342MC-T12	L. E. D.			C403	QAD0HZ-10AZM	AL E. CAP.	
	D427	SLA-380JT3F	L. E. D.			C404	QEK51HM-225G	2.2MF 50V AL E. CAP.	
	D431	SLR-342MCA47	L. E. D.			C405	QCHB1EZ-223	0.022MF 25V CER. CAP.	
	D432	SLR-342MCA47	L. E. D.			C406	QCB1HK-331Y	330PF 50V CER. CAP.	
	D433	SLR-342MCA47	L. E. D.			C407	QCVB1CM-103Y	0.01MF 16V CER. CAP.	
	D435	SLR-342MCA47	L. E. D.			C408	QCHB1EZ-223	0.022MF 25V CER. CAP.	
	D436	SLR-342MCA47	L. E. D.			C409	QCFB1HZ-473Y	0.047MF 50V CER. CAP.	
	D437	SLR-342MCA47	L. E. D.			C411	QCZ0202-155	1.5MF 25V CER. RES.	
	D438	SLR-342MCA47	L. E. D.			C412	QETC1AM-107ZN	100MF 10V E. CAP.	
	D439	SLR-342MCA47	L. E. D.			C420	QETB1AM-227	220MF 10V E. CAP.	
	D440	SLR-342DCA47	L. E. D.			C421	QETB1HM-475E	4.7MF 50V E. CAP.	
	D441	SLR-342DCA47	L. E. D.			C422	QETB1HM-106	10MF 50V E. CAP.	
	D442	SLR-342DCA47	L. E. D.			C423	QETB1HM-475E	4.7MF 50V E. CAP.	
	D443	SLR-342DCA47	L. E. D.			C850	QETB1CM-476	47MF 16V AL E. CAP.	
	D444	SLR-342DCA47	L. E. D.			C851	QFN82AK-472	4700PF 100V METAL MYLAR	
	D445	SLR-342DCA47	L. E. D.			C852	QETC1EM-227ZN	220MF 25V AL E. CAP.	
	D461	1SS133	SI. DIODE				RESISTORS		
	D462	1SS133	SI. DIODE			R051	QRD161J-222	2.2K 1/6W CARBON RES.	
	D463	1SS133	SI. DIODE			R052	QRD161J-104	100K 1/6W CARBON RES.	
	D464	1SS133	SI. DIODE			R053	QRD161J-123	12K 1/6W CARBON RES.	
	D472	1SS133	SI. DIODE			R054	QRD161J-162	1.6K 1/6W CARBON RES.	
	D857	MTZ6 2JC	ZENER DIODE			R055	QRD161J-104	100K 1/6W CARBON RES.	
	D858	1SS133	SI. DIODE		△	R056	QRD14CJ-181S	180 1/4W UNF. CARBON	
	D871	1SR139-200	SI. DIODE		△	R057	QRD14CJ-272S	2.7K 1/4W UNF. CARBON	
	D872	1SR139-200	SI. DIODE			R058	QRD167J-272	2.7K 1/6W CARBON RES.	
	D873	1SR139-200	SI. DIODE			R059	QRD167J-272	2.7K 1/6W CARBON RES.	
	D874	1SR139-200	SI. DIODE			R060	QRD167J-272	2.7K 1/6W CARBON RES.	
		TRANSISTORS			△	R063	QRD14CJ-100SX	10 1/4W UNF. CARBON	
	Q051	2SC2240 (GR. BL)	SI. TRANSISTOR		△	R064	QRD14CJ-100SX	10 1/4W UNF. CARBON	
	Q052	2SC2240 (GR. BL)	SI. TRANSISTOR		△		QRD14CJ-270SX	27 1/4W UNF. CARBON	
	Q053	2SA1038 (R. S)	SI. TRANSISTOR		△	R065	QRD14CJ-561SX	560 1/4W UNF. CARBON	
	Q055	2SC2235 (O. Y)	SI. TRANSISTOR		△	R066	QRD14CJ-100SX	10 1/4W UNF. CARBON	
	Q057	2SA965 (Y)	SI. TRANSISTOR		△		QRD14CJ-270SX	27 1/4W UNF. CARBON	
	Q059	2SC1775AV (F1)	SI. TRANSISTOR		△	R067	QRD14CJ-100SX	10 1/4W UNF. CARBON	
	Q061	2SC2389 (S. E)	SI. TRANSISTOR			R068	QRD161J-391	390 1/6W CARBON RES.	
	Q062	2SA1038 (R. S)	SI. TRANSISTOR			R069	ERT-D2WHL202S	2K 1/4W NEGATIVE TH	
	Q401	DTC114YS	DIGITAL TRANSISTOR			R070	QRD161J-183	18K 1/6W CARBON RES.	
	Q402	DTC114TN	DIGITAL TRANSISTOR			R071	QRD161J-123	12K 1/6W CARBON RES.	
	Q403	DTC144WS	DIGITAL TRANSISTOR		△	R072	QRD125J-330	33 1/2W UNF. CARBON	
	Q404	DTC114YS	DIGITAL TRANSISTOR		△	R077	QRG022J-562A	5.6K 2W OXIDE METAL	
	Q405	DTC144ES	DIGITAL TRANSISTOR			R078	QRD167J-751	750 1/6W CARBON RES.	
	Q406	DTC114YS	DIGITAL TRANSISTOR			R083	QRD161J-102	1K 1/6W CARBON RES.	
	Q410	DTC144ES	DIGITAL TRANSISTOR		△	R087	QRD14CJ-101S	100 1/4W UNF. CARBON	
	Q411	DTA114YS	DIGITAL TRANSISTOR		△	R088	QRD14CJ-101S	100 1/4W UNF. CARBON	
	Q852	2SC2235 (O. Y)	SI. TRANSISTOR			R090	QRZ0197-R22	0.22 1W NETWORK RE	
	Q853	DTC123YS	DIGITAL TRANSISTOR			R095	QRD167J-151	150 1/6W CARBON RES.	

■ Electric Parts List (Display Control P. W. B.)

△	Item	Parts Number	Description	Area
		I. C. S		
	IC401	MN101C01DAC1	I. C (M)	
	IC402	GP1U271X	INFRARED DETECT UNIT	
	IC403	PST600E-T	I. C (MONO-ANALOG)	
	IC411	MN171602JAAN	I. C (MICRO-COMPUTER)	
		DIODES		
	D050	1SS133	SI. DIODE	
	D051	MTZ18JC	ZENER DIODE	
	D052	1SS133	SI. DIODE	
	D053	1SS133	SI. DIODE	
	D061	1SS133	SI. DIODE	
	D062	1SS133	SI. DIODE	
	D292	1SS133	SI. DIODE	
	D404	1SS133	SI. DIODE	
	D406	1SS133	SI. DIODE	
	D407	1SS133	SI. DIODE	
	D415	1SR139-200	SI. DIODE	
	D416	1SR139-200	SI. DIODE	
	D417	1SR139-200	SI. DIODE	
	D418	1SS133	SI. DIODE	
	D419	1SS133	SI. DIODE	
	D421	1SS133	SI. DIODE	
	D425	SLR-342MC-T12	L. E. D.	
	D427	SLA-380JT3F	L. E. D.	
	D431	SLR-342MCA47	L. E. D.	
	D432	SLR-342MCA47	L. E. D.	
	D433	SLR-342MCA47	L. E. D.	
	D435	SLR-342MCA47	L. E. D.	
	D436	SLR-342MCA47	L. E. D.	
	D437	SLR-342MCA47	L. E. D.	
	D438	SLR-342MCA47	L. E. D.	
	D439	SLR-342MCA47	L. E. D.	
	D440	SLR-342DCA47	L. E. D.	
	D441	SLR-342DCA47	L. E. D.	
	D442	SLR-342DCA47	L. E. D.	
	D443	SLR-342DCA47	L. E. D.	
	D444	SLR-342DCA47	L. E. D.	
	D445	SLR-342DCA47	L. E. D.	
	D461	1SS133	SI. DIODE	
	D462	1SS133	SI. DIODE	
	D463	1SS133	SI. DIODE	
	D464	1SS133	SI. DIODE	
	D472	1SS133	SI. DIODE	
	D857	MTZ6.2JC	ZENER DIODE	
	D858	1SS133	SI. DIODE	
	D871	1SR139-200	SI. DIODE	
	D872	1SR139-200	SI. DIODE	
	D873	1SR139-200	SI. DIODE	
	D874	1SR139-200	SI. DIODE	
		TRANSISTORS		
	Q051	2SC2240 (GR. BL)	SI. TRANSISTOR	
	Q052	2SC2240 (GR. BL)	SI. TRANSISTOR	
	Q053	2SA1038 (R. S)	SI. TRANSISTOR	
	Q055	2SC2235 (O. Y)	SI. TRANSISTOR	
	Q057	2SA965 (Y)	SI. TRANSISTOR	
	Q059	2SC1775AV (F1)	SI. TRANSISTOR	
	Q061	2SC2389 (S. E)	SI. TRANSISTOR	
	Q062	2SA1038 (R. S)	SI. TRANSISTOR	
	Q401	DTC114YS	DIGITAL TRANSISTOR	
	Q402	DTC114TN	DIGITAL TRANSISTOR	
	Q403	DTC144WS	DIGITAL TRANSISTOR	
	Q404	DTC114YS	DIGITAL TRANSISTOR	
	Q405	DTC144ES	DIGITAL TRANSISTOR	
	Q406	DTC114YS	DIGITAL TRANSISTOR	
	Q410	DTC144ES	DIGITAL TRANSISTOR	
	Q411	DTA114YS	DIGITAL TRANSISTOR	
	Q852	2SC2235 (O. Y)	SI. TRANSISTOR	
	Q853	DTC123YS	DIGITAL TRANSISTOR	
		CAPACITORS		

△	Item	Parts Number	Description	Area
	C001	QCZ9019-472	4700PF C. CAP.	
	C002	QCZ9019-472	4700PF C. CAP.	
	C050	QCHB1EZ-223	0.022MF 25V CER. CAP.	
	C051	QETB1HM-106	10MF 50V E. CAP.	
	C052	QCS31HJ-331Z	330PF 50V CER. CAP.	
	C053	QETB1EM-106	10MF 25V AL E. CAP.	
	C054	QCS21HJ-101A	100PF 50V CER. CAP.	
	C055	QCS21HJ-5R0	5PF 50V CER. CAP.	
	C056	QETB1CM-476	47MF 16V AL E. CAP.	
	C057	QCS22HJ-330	33PF 500V CER. CAP.	
	C058	QFLB1HJ-103	0.01MF 50V MYLAR CAP.	
	C059	QETB1HM-476	47MF 50V E. CAP.	
	C060	QCS22HJ-470A	47PF 500V CER. CAP.	
	C061	QETB1HM-225	2.2MF 50V AL E. CAP.	
	C063	QCS22HJ-470A	47PF 500V CER. CAP.	
	C066	QCF21HP-223A	0.022MF 50V CER. CAP.	
	C067	QCY31HK-332Z	3300PF 50V CER. CAP.	
	C068	QCY31HK-332Z	3300PF 50V CER. CAP.	
	C291	QCS31HJ-471Z	470PF 50V CER. CAP.	
	C294	QCS31HJ-681Z	680PF 50V CER. CAP.	
	C401	QETB1AM-227	220MF 10V E. CAP.	
	C402	QCZ0202-155	1.5MF 25V CER. RES.	
	C403	QEAD0HZ-10AZM	AL E. CAP.	
	C404	QEK51HM-225G	2.2MF 50V AL E. CAP.	
	C405	QCHB1EZ-223	0.022MF 25V CER. CAP.	
	C406	QCB1HK-331Y	330PF 50V CER. CAP.	
	C407	QCVB1CM-103Y	0.01MF 16V CER. CAP.	
	C408	QCHB1EZ-223	0.022MF 25V CER. CAP.	
	C409	QCFB1HZ-473Y	0.047MF 50V CER. CAP.	
	C411	QCZ0202-155	1.5MF 25V CER. RES.	
	C412	QETC1AM-107ZN	100MF 10V E. CAP.	
	C420	QETB1AM-227	220MF 10V E. CAP.	
	C421	QETB1HM-475E	4.7MF 50V E. CAP.	
	C422	QETB1HM-106	10MF 50V E. CAP.	
	C423	QETB1HM-475E	4.7MF 50V E. CAP.	
	C850	QETB1CM-476	47MF 16V AL E. CAP.	
	C851	QFN82AK-472	4700PF 100V METAL. MYLAR	
	C852	QETC1EM-227ZN	220MF 25V AL E. CAP.	
		RESISTORS		
	R051	QRD161J-222	2.2K 1/6W CARBON RES.	
	R052	QRD161J-104	100K 1/6W CARBON RES.	
	R053	QRD161J-123	12K 1/6W CARBON RES.	
	R054	QRD161J-162	1.6K 1/6W CARBON RES.	
	R055	QRD161J-104	100K 1/6W CARBON RES.	
	R056	QRD14CJ-181S	180 1/4W UNF. CARBON R	
	R057	QRD14CJ-272S	2.7K 1/4W UNF. CARBON R	
	R058	QRD167J-272	2.7K 1/6W CARBON RES.	
	R059	QRD167J-272	2.7K 1/6W CARBON RES.	
	R060	QRD167J-272	2.7K 1/6W CARBON RES.	
	R063	QRD14CJ-100SX	10 1/4W UNF. CARBON R	
	R064	QRD14CJ-100SX	10 1/4W UNF. CARBON R	
	R065	QRD14CJ-270SX	27 1/4W UNF. CARBON R	
	R066	QRD14CJ-561SX	560 1/4W UNF. CARBON R	
	R067	QRD14CJ-100SX	10 1/4W UNF. CARBON R	
	R068	QRD14CJ-270SX	27 1/4W UNF. CARBON R	
	R069	QRD14CJ-100SX	10 1/4W UNF. CARBON R	
	R068	QRD161J-391	390 1/6W CARBON RES.	
	R069	ERT-D2WHL202S	2K 1/4W NEGATIVE THE	
	R070	QRD161J-183	18K 1/6W CARBON RES.	
	R071	QRD161J-123	12K 1/6W CARBON RES.	
	R072	QRD125J-330	33 1/2W UNF. CARBON R	
	R077	QRG022J-562A	5.6K 2W OXIDE METAL	
	R078	QRD167J-751	750 1/6W CARBON RES.	
	R083	QRD161J-102	1K 1/6W CARBON RES.	
	R087	QRD14CJ-101S	100 1/4W UNF. CARBON R	
	R088	QRD14CJ-101S	100 1/4W UNF. CARBON R	
	R090	QRZ0197-R22	0.22 1W NETWORK RES.	
	R095	QRD167J-151	150 1/6W CARBON RES.	
	R096	QRD167J-151	150 1/6W CARBON RES.	

■ Electric Parts List (Display Control P. W. B.)

△	Item	Parts Number	Description	Area
	R097	QRD167J-151	150 1/6W CARBON RES.	
	R098	QRD167J-151	150 1/6W CARBON RES.	
	R291	QRD161J-221	220 1/6W CARBON RES.	
	R292	QRD161J-221	220 1/6W CARBON RES.	
	R293	QRD161J-221	220 1/6W CARBON RES.	
	R299	QRD161J-102	1K 1/6W CARBON RES.	
	R403	QRD161J-101	100 1/6W CARBON RES.	
	R410	QRD167J-223	22K 1/6W CARBON RES.	
	R411	QRD161J-472	4.7K 1/6W CARBON RES.	
	R414	QRD161J-103	10K 1/6W CARBON RES.	
	R415	QRD161J-103	10K 1/6W CARBON RES.	
	R416	QRD161J-103	10K 1/6W CARBON RES.	
	R417	QRD161J-103	10K 1/6W CARBON RES.	
	R418	QRD161J-471	470 1/6W CARBON RES.	
	R419	QRD161J-103	10K 1/6W CARBON RES.	
	R420	QRD161J-103	10K 1/6W CARBON RES.	
	R421	QRD161J-103	10K 1/6W CARBON RES.	
	R422	QRD161J-103	10K 1/6W CARBON RES.	
	R425	QRD161J-221	220 1/6W CARBON RES.	
	R427	QRD161J-221	220 1/6W CARBON RES.	
△	R428	QRD14CJ-220S	22 1/4W UNF. CARBON R	
	R429	QRD161J-103	10K 1/6W CARBON RES.	
	R430	QRD161J-104	100K 1/6W CARBON RES.	
	R431	QRD161J-221	220 1/6W CARBON RES.	
	R432	QRD161J-221	220 1/6W CARBON RES.	
	R433	QRD161J-221	220 1/6W CARBON RES.	
	R434	QRD161J-221	220 1/6W CARBON RES.	
	R435	QRD161J-221	220 1/6W CARBON RES.	
	R436	QRD161J-221	220 1/6W CARBON RES.	
	R437	QRD161J-221	220 1/6W CARBON RES.	
	R440	QRD161J-221	220 1/6W CARBON RES.	
	R442	QRD161J-221	220 1/6W CARBON RES.	
	R443	QRD161J-221	220 1/6W CARBON RES.	
	R444	QRD161J-221	220 1/6W CARBON RES.	
	R445	QRD161J-221	220 1/6W CARBON RES.	
	R447	QRD161J-221	220 1/6W CARBON RES.	
	R448	QRD161J-221	220 1/6W CARBON RES.	
	R449	QRD161J-221	220 1/6W CARBON RES.	
	R453	QRD161J-221	220 1/6W CARBON RES.	
	R454	QRD161J-221	220 1/6W CARBON RES.	
	R455	QRD161J-221	220 1/6W CARBON RES.	
	R456	QRD161J-221	220 1/6W CARBON RES.	
	R457	QRD161J-221	220 1/6W CARBON RES.	
	R458	QRD161J-221	220 1/6W CARBON RES.	
	R459	QRD161J-221	220 1/6W CARBON RES.	
	R460	QRD161J-221	220 1/6W CARBON RES.	
	R461	QRD161J-221	220 1/6W CARBON RES.	
	R462	QRD161J-221	220 1/6W CARBON RES.	
	R466	QRD161J-221	220 1/6W CARBON RES.	
	R467	QRD161J-103	10K 1/6W CARBON RES.	
	R470	QRD161J-221	220 1/6W CARBON RES.	
	R474	QRD161J-221	220 1/6W CARBON RES.	
	R480	QRD161J-104	100K 1/6W CARBON RES.	
	R481	QRD161J-104	100K 1/6W CARBON RES.	
	R482	QRD161J-104	100K 1/6W CARBON RES.	
	R483	QRD161J-104	100K 1/6W CARBON RES.	
	R484	QRD161J-104	100K 1/6W CARBON RES.	
△	R860	QRD14CJ-100SX	10 1/4W UNF. CARBON R	
△	R861	QRD14CJ-100SX	10 1/4W UNF. CARBON R	
		QRZ0077-220X	22 1/4W FUSIBLE RES.	
	R863	QRD161J-821	820 1/6W CARBON RES.	
	RA411	QRB049J-103	10K 1/10WRES.	
		OTHERS		
		EMW10702-003	CIR BOARD	EF
		EMW10702-003	CIR BOARD	EN
		EMW10702-003	CIR BOARD	G
		EMW10702-003BS	CIR BOARD	BS
		QWE881-14RR	VINYL WIRE	
		QWE886-14RR	VINYL WIRE	

△	Item	Parts Number	Description	Area
	J003	EMV5137-002	CONNECT TERMINAL	
	J291	QMS3L10-0A0	MICROPHONE JACK	
	J292	QMS3L10-0A0	MICROPHONE JACK	
	J293	QMS3L10-0A0	MICROPHONE JACK	
	J295	EMN00TV-119AJ4	PIN JACK	
	L051	EGL0011-R45J1	INDUCTOR	
	S401	ESP0001-023M	TACT SWITCH	
	S403	ESP0001-023M	TACT SWITCH	
	S404	ESP0001-023M	TACT SWITCH	
	S405	ESP0001-023M	TACT SWITCH	
	S406	ESP0001-023M	TACT SWITCH	
	S407	ESP0001-023M	TACT SWITCH	
	S408	ESP0001-023M	TACT SWITCH	
	S409	ESP0001-023M	TACT SWITCH	
	S410	ESP0001-023M	TACT SWITCH	
	S411	ESP0001-023M	TACT SWITCH	
	S412	ESP0001-023M	TACT SWITCH	
	S413	ESP0001-023M	TACT SWITCH	
	S414	ESP0001-023M	TACT SWITCH	
	S415	ESP0001-023M	TACT SWITCH	
	S416	ESP0001-023M	TACT SWITCH	
	S417	ESP0001-023M	TACT SWITCH	
	S425	ESP0001-023M	TACT SWITCH	
	S426	ESP0001-023M	TACT SWITCH	
	S427	ESP0001-023M	TACT SWITCH	
△	T002	ETP1000-41EA	POWER TRASNFORMER	EF EN G
△		ETP1000-41EABS	POWER TRASNFORMER	BS
	X401	ECX0008-000KMZ	CRYSTAL	
	X411	ECXP6R0-001ZA	CRYSTAL	
	BK400	E309106-001SM	FL HOLDER	
	CN102	EWS265-A932	SOCKET WIRE ASSY	
	CN301	EWS268-A920J	SOCKET WIRE ASSY	
	CN302	EWS293-0116	SOCKET WIRE	
	CN401	VMC0163-R21	CONNECT TERMINAL	
	CN402	EWS26A-A210	SOCKET WIRE ASSY	
	CN403	EWS26E-A210	SOCKET WIRE ASSY	
	CN404	EWS269-A422J	SOCKET WIRE ASSY	
		LE40485-001A	WIRE ASSY	
	CN405	VMC0163-R13	CONNECT TERMINAL	
	CN412	EMV5109-010A	CONNECT TERMINAL	
	CN413	EMV5109-014A	PIN PLUG	
	CN711	EMV5163-006R	CONNECT TERMINAL	
	CN804	VMC0177-003	CONNECT TERMINAL	
	D1400	ELU0001-215	FLUORESCENT DISPLAY TUBE	
	EP001	EMZ4002-002Z	EARTH PLATE	
	FC001	EMG7331-003Z	FUSE CLIP	
	FC002	EMG7331-003Z	FUSE CLIP	
	FC003	EMG7331-003Z	FUSE CLIP	
	FC004	EMG7331-003Z	FUSE CLIP	
	FS001	E3400-444	FELT SPACER	
	FS002	E3400-444	FELT SPACER	
	HL401	VYH7653-002	I. C. PROTECTOR	
	JS401	QSJ4003-E01	PUSH SWITCH	
	LA001	E67132-T3R15	FUSE LABEL	
△	RY002	ESK1D12-115	RELAY	EF EN G
		ESK1D12-115BS	RELAY	BS
	TA001	EMZ4001-002Z	TAB	
	TA002	EMZ4001-002Z	TAB	

■Electric Parts List(Source Select Video Output P.W.B.)

△	Item	Parts Number	Description	Area
	C392	QCHB1EZ-223	0.022MF 25V CER. CAP.	
	C395	QCBB1HK-561Y	560PF 50V CER. CAP.	
	C396	QETB1EM-476	47MF 25V AL. E. CAP.	
	C397	QETB1EM-476	47MF 25V AL. E. CAP.	
	C398	QETB1EM-476	47MF 25V AL. E. CAP.	
	C399	QETB1EM-476	47MF 25V AL. E. CAP.	
	C551	QETB1HM-475E	4.7MF 50V E. CAP.	
	C552	QETB1HM-475E	4.7MF 50V E. CAP.	
	C553	QCBB1HK-101Y	100PF 50V CER. CAP.	
	C554	QCBB1HK-101Y	100PF 50V CER. CAP.	
	C555	QETB1HM-475E	4.7MF 50V E. CAP.	
	C556	QETB1HM-475E	4.7MF 50V E. CAP.	
	C557	QER51HM-475	4.7MF 50V AL. E. CAP.	
	C558	QER51HM-475	4.7MF 50V AL. E. CAP.	
	C559	QETB1HM-475E	4.7MF 50V E. CAP.	
	C560	QETB1HM-475E	4.7MF 50V E. CAP.	
	C563	QCHB1EZ-223	0.022MF 25V CER. CAP.	
	C564	QETB1CM-226	22MF 16V E. CAP.	
	C565	QCHB1EZ-223	0.022MF 25V CER. CAP.	
	C566	QETB1CM-226	22MF 16V E. CAP.	
	C567	QCHB1EZ-223	0.022MF 25V CER. CAP.	
	C569	QCSB1HJ-470	47PF 50V CER. CAP.	
	C570	QCSB1HJ-470	47PF 50V CER. CAP.	
	C571	QFV81HJ-333	0.033MF 50V THIN FILM CAP.	
	C572	QFV81HJ-333	0.033MF 50V THIN FILM CAP.	
	C573	QETB1HM-105	1MF 50V AL. E. CAP.	
	C574	QETB1HM-105	1MF 50V AL. E. CAP.	
	C575	QFLB1HJ-332	3300PF 50V MYLAR CAP.	
	C576	QFLB1HJ-332	3300PF 50V MYLAR CAP.	
	C577	QFV81HJ-104	0.1MF 50V THIN FILM CAP.	
	C578	QFV81HJ-104	0.1MF 50V THIN FILM CAP.	
	C579	QCS31HJ-331Z	330PF 50V CER. CAP.	
	C580	QCS31HJ-331Z	330PF 50V CER. CAP.	
	C581	QCF21HP-103A	0.01MF 50V CER. CAP.	
	C582	QCF21HP-103A	0.01MF 50V CER. CAP.	
	C601	QETB1HM-105	1MF 50V AL. E. CAP.	
	C602	QETB1HM-105	1MF 50V AL. E. CAP.	
	C603	QFLB1HJ-104	0.1MF 50V MYLAR CAP.	
	C604	QFLB1HJ-104	0.1MF 50V MYLAR CAP.	
	C605	QFLB1HJ-104	0.1MF 50V MYLAR CAP.	
	C606	QFLB1HJ-104	0.1MF 50V MYLAR CAP.	
	C607	QETB1HM-474	0.47MF 50V E. CAP.	
	C608	QETB1HM-474	0.47MF 50V E. CAP.	
	C609	QETB1HM-475E	4.7MF 50V E. CAP.	
	C610	QETB1HM-475E	4.7MF 50V E. CAP.	
	C611	QETB1HM-474	0.47MF 50V E. CAP.	
	C612	QETB1HM-474	0.47MF 50V E. CAP.	
	C613	QETB1HM-475E	4.7MF 50V E. CAP.	
	C614	QETB1HM-475E	4.7MF 50V E. CAP.	
	C615	QFV81HJ-154	0.15MF 50V THIN FILM CAP.	
	C616	QFV81HJ-154	0.15MF 50V THIN FILM CAP.	
	C617	QETB1HM-335	3.3MF 50V AL. E. CAP.	
	C618	QETB1HM-335	3.3MF 50V AL. E. CAP.	
	C619	QFV81HJ-154	0.15MF 50V THIN FILM CAP.	
	C620	QFV81HJ-154	0.15MF 50V THIN FILM CAP.	
	C621	QFN31HJ-223ZN	0.022MF 50V MYLAR CAP.	
	C622	QFN31HJ-473ZN	0.047MF 50V MYLAR CAP.	
	C623	QETC1EM-227ZN	220MF 25V AL. E. CAP.	
	C624	QETB1EM-106	10MF 25V AL. E. CAP.	
	C625	QETB1EM-106	10MF 25V AL. E. CAP.	
	C626	QETB1EM-106	10MF 25V AL. E. CAP.	
	C627	QETB1EM-106	10MF 25V AL. E. CAP.	
	C628	QETC1EM-227ZN	220MF 25V AL. E. CAP.	
	C631	QETB1EM-476	47MF 25V AL. E. CAP.	
	C632	QFV71HJ-474ZM	0.47MF 50V THIN FILM CAP.	
	C633	QCS31HJ-681Z	680PF 50V CER. CAP.	

△	Item	Parts Number	Description	Area
	C634	QETC1EM-227ZN	220MF 25V AL. E. CAP.	
	C641	QETB1HM-474	0.47MF 50V E. CAP.	
	C643	QETB1HM-225	2.2MF 50V AL. E. CAP.	
	C644	QETC1EM-227ZN	220MF 25V AL. E. CAP.	
	C645	QFN81HJ-823	0.082MF 50V METAL MYLAR	
	C646	QFN31HJ-332Z	3300PF 50V MYLAR CAP.	
	C647	QFN81HJ-823	0.082MF 50V METAL MYLAR	
	C648	QETB1HM-474	0.47MF 50V E. CAP.	
	C649	QCZ0205-155	1.5MF 25V C. CAP.	
	C650	QETC1EM-227ZN	220MF 25V AL. E. CAP.	
	C651	QCS21HJ-300	30PF 50V CER. CAP.	
	C652	QCS21HJ-300	30PF 50V CER. CAP.	
	C881	QCE22HP-103A	0.01MF 500V CER. CAP.	
		QFN82CK-104	0.1MF 160V METAL MYLAR	
	C882	QCE22HP-103A	0.01MF 500V CER. CAP.	
		QFN82CK-104	0.1MF 160V METAL MYLAR	
	C883	QCE22HP-103A	0.01MF 500V CER. CAP.	
		QFN82CK-104	0.1MF 160V METAL MYLAR	
	C888	QCF21HP-223A	0.022MF 50V CER. CAP.	
		RESISTORS		
	R221	QRD161J-750	75 1/6W CARBON RES.	
	R222	QRD161J-750	75 1/6W CARBON RES.	
	R223	QRD161J-750	75 1/6W CARBON RES.	
	R224	QRD167J-680	68 1/6W CARBON RES.	
	R225	QRD167J-332	3.3K 1/6W CARBON RES.	
	R226	QRD167J-332	3.3K 1/6W CARBON RES.	
	R235	QRD161J-331	330 1/6W CARBON RES.	
	R236	QRD161J-331	330 1/6W CARBON RES.	
	R251	QAD0095-4R7Z	4.7PF POSITIVE THE	
	R252	QRD167J-152	1.5K 1/6W CARBON RES.	
	R253	QRD167J-223	22K 1/6W CARBON RES.	
	R254	QRD161J-104	100K 1/6W CARBON RES.	
△	R262	QRX012J-2R2AF	2.2 1W METAL FILM R	
	R263	QRD167J-562	5.6K 1/6W CARBON RES.	
	R264	QRD167J-822	8.2K 1/6W CARBON RES.	
	R265	QRD161J-103	10K 1/6W CARBON RES.	
△	R266	QRD14CJ-2R2SX	2.2 1/4W UNF. CARBON R	
	R301	QRD161J-222	2.2K 1/6W CARBON RES.	
	R302	QRD161J-222	2.2K 1/6W CARBON RES.	
	R303	QRD161J-473	47K 1/6W CARBON RES.	
	R304	QRD161J-473	47K 1/6W CARBON RES.	
	R305	QRD161J-561	560 1/6W CARBON RES.	
	R306	QRD161J-561	560 1/6W CARBON RES.	
	R307	QRD161J-393	39K 1/6W CARBON RES.	
	R308	QRD161J-393	39K 1/6W CARBON RES.	
	R309	QRD161J-474	470K 1/6W CARBON RES.	
	R310	QRD161J-474	470K 1/6W CARBON RES.	
	R311	QRD161J-104	100K 1/6W CARBON RES.	
	R312	QRD161J-104	100K 1/6W CARBON RES.	
△	R313	QRD14CJ-391SX	390 1/4W UNF. CARBON R	
△	R314	QRD14CJ-391SX	390 1/4W UNF. CARBON R	
△	R321	QRZ0077-680	68 1/4W FUSIBLE RES.	
△	R322	QRZ0077-680	68 1/4W FUSIBLE RES.	
	R325	QRD161J-471	470 1/6W CARBON RES.	
	R326	QRD161J-471	470 1/6W CARBON RES.	
	R327	QRD161J-222	2.2K 1/6W CARBON RES.	
	R328	QRD161J-222	2.2K 1/6W CARBON RES.	
	R329	QRD161J-471	470 1/6W CARBON RES.	
	R330	QRD161J-471	470 1/6W CARBON RES.	
	R331	QRD161J-471	470 1/6W CARBON RES.	
	R332	QRD161J-471	470 1/6W CARBON RES.	
	R333	QRD161J-471	470 1/6W CARBON RES.	
	R334	QRD161J-471	470 1/6W CARBON RES.	
	R335	QRD161J-222	2.2K 1/6W CARBON RES.	
	R336	QRD161J-222	2.2K 1/6W CARBON RES.	
	R337	QRD161J-471	470 1/6W CARBON RES.	

■ Electric Parts List (Source Select Video Output P.W.B.)

△	Item	Parts Number	Description	Area	△	Item	Parts Number	Description	Area
		I. C. S				C303	QCS21HJ-101A	100PF 50V CER. CAP.	
	IC221	NJM2279D	I. C (MONO-ANALOG)			C304	QCS21HJ-101A	100PF 50V CER. CAP.	
	IC301	NJM4580DD	I. C (MONO-ANALOG)			C305	QFLB1HJ-182	1800PF 50V MYLAR CAP.	
	IC305	TC9212P	I. C (DIGI-MOS)			C306	QFLB1HJ-182	1800PF 50V MYLAR CAP.	
	IC306	NJM4580LD	I. C (MONO-ANALOG)			C307	QFLB1HJ-682	6800PF 50V MYLAR CAP.	
	IC307	TC9213P	I. C (DIGI-MOS)			C308	QFLB1HJ-682	6800PF 50V MYLAR CAP.	
	IC308	NJM4580LD	I. C (MONO-ANALOG)			C309	QCS21HJ-101A	100PF 50V CER. CAP.	
	IC311	BA15218N	I. C (MONO-ANALOG)			C310	QCS21HJ-101A	100PF 50V CER. CAP.	
	IC321	TC9274N-007	I. C (M)			C311	QETB1HM-475E	4.7MF 50V E. CAP.	
	IC551	LC7522	I. C (DIGI-MOS)			C312	QETB1HM-475E	4.7MF 50V E. CAP.	
	IC552	M5243P12	I. C (MONO-ANALOG)			C313	QETC1AM-107ZN	100MF 10V E. CAP.	
	IC601	LA2786	I. C (MONO-ANALOG)			C314	QETC1AM-107ZN	100MF 10V E. CAP.	
	IC641	LV1016	I. C (M)			C315	QETB1CM-476	47MF 16V AL E. CAP.	
		DIODES				C316	QETB1CM-476	47MF 16V AL E. CAP.	
	D225	1SS133	SI. DIODE			C319	QCF21HP-223A	0.022MF 50V CER. CAP.	
	D226	1SS133	SI. DIODE			C320	QCF21HP-223A	0.022MF 50V CER. CAP.	
	D227	1SS133	SI. DIODE			C321	QETB1EM-226N	22MF 25V E. CAP.	
	D228	1SS133	SI. DIODE			C322	QETB1EM-226N	22MF 25V E. CAP.	
	D251	MTZ6.2JC	ZENER DIODE			C323	QCS31HJ-331Z	330PF 50V CER. CAP.	
	D252	1SR139-200	SI. DIODE			C324	QCS31HJ-331Z	330PF 50V CER. CAP.	
	D253	1SR139-200	SI. DIODE			C325	QCS31HJ-331Z	330PF 50V CER. CAP.	
	D254	MTZ39JCT-77	ZENER DIODE			C326	QCS31HJ-331Z	330PF 50V CER. CAP.	
	D255	1SR139-200	SI. DIODE			C327	QCS31HJ-331Z	330PF 50V CER. CAP.	
	D261	1SR139-200	SI. DIODE			C328	QCS31HJ-331Z	330PF 50V CER. CAP.	
	D262	1SR139-200	SI. DIODE			C329	QCS31HJ-331Z	330PF 50V CER. CAP.	
△	D263	10E2-FD	DIODE			C330	QCS31HJ-331Z	330PF 50V CER. CAP.	
△	D264	10E2-FD	DIODE			C331	QCS31HJ-331Z	330PF 50V CER. CAP.	
	D265	1SS133	SI. DIODE			C332	QCS31HJ-331Z	330PF 50V CER. CAP.	
	D551	MTZ6.8JC	ZENER DIODE			C333	QCS31HJ-331Z	330PF 50V CER. CAP.	
	D552	MTZ6.8JC	ZENER DIODE			C334	QCS31HJ-331Z	330PF 50V CER. CAP.	
	D881	U6SBA20	DIODE			C335	QCS31HJ-331Z	330PF 50V CER. CAP.	
		TRANSISTORS				C336	QCS31HJ-331Z	330PF 50V CER. CAP.	
	Q251	2SB1357 (E. F)	SI. TRANSISTOR			C337	QCS31HJ-331Z	330PF 50V CER. CAP.	
	Q252	2SC2240 (GR. BL)	SI. TRANSISTOR			C338	QCS31HJ-331Z	330PF 50V CER. CAP.	
	Q254	DTA144ES	DIGITAL TRANSISTOR			C341	QETB1HM-475E	4.7MF 50V E. CAP.	
	Q255	DTC114ES	DIGITAL TRANSISTOR			C342	QETB1HM-475E	4.7MF 50V E. CAP.	
	Q301	2SD2144S (VW)	SI. TRANSISTOR			C343	QCSB1HJ-680	68PF 50V CER. CAP.	
	Q302	2SD2144S (VW)	SI. TRANSISTOR			C344	QCSB1HJ-680	68PF 50V CER. CAP.	
	Q303	DTA144ES	DIGITAL TRANSISTOR			C345	QETB1EM-226N	22MF 25V E. CAP.	
	Q306	2SD2144S (VW)	SI. TRANSISTOR			C346	QETB1EM-226N	22MF 25V E. CAP.	
		CAPACITORS				C347	QCF21HP-223A	0.022MF 50V CER. CAP.	
	C221	QETB0JM-477	470MF 6.3V AL E. CAP.			C348	QCF21HP-223A	0.022MF 50V CER. CAP.	
	C222	QETB1CM-476	47MF 16V AL E. CAP.			C351	QETB1HM-225	2.2MF 50V AL E. CAP.	
	C223	QCVB1CM-103Y	0.01MF 16V CER. CAP.			C352	QETB1HM-225	2.2MF 50V AL E. CAP.	
	C224	QCVB1CM-103Y	0.01MF 16V CER. CAP.			C353	QETB1HM-106	10MF 50V E. CAP.	
	C232	QETB1HM-106	10MF 50V E. CAP.			C354	QETB1HM-106	10MF 50V E. CAP.	
	C233	QETB1HM-106	10MF 50V E. CAP.			C355	QETB0JM-107	100MF 6.3V AL E. CAP.	
	C234	QCS21HJ-470	47PF 50V CER. CAP.			C359	QETB1HM-475E	4.7MF 50V E. CAP.	
	C235	QCS21HJ-470	47PF 50V CER. CAP.			C360	QETB1HM-475E	4.7MF 50V E. CAP.	
	C251	QETB1HM-227	220MF 50V E. CAP.			C361	QETB1HM-475E	4.7MF 50V E. CAP.	
	C252	QETB1JM-227	220MF 63V AL E. CAP.			C362	QETB1HM-475E	4.7MF 50V E. CAP.	
	C253	QETB1HM-105	1MF 50V AL E. CAP.			C375	QCHB1EZ-223	0.022MF 25V CER. CAP.	
	C254	QETB1HM-226E	22MF 50V E. CAP.			C376	QCHB1EZ-223	0.022MF 25V CER. CAP.	
	C255	QETB1HM-226E	22MF 50V E. CAP.			C377	QGBB1HK-561Y	560PF 50V CER. CAP.	
	C259	QFLB1HJ-473	0.047MF 50V MYLAR CAP.			C378	QGBB1HK-561Y	560PF 50V CER. CAP.	
	C260	QFLB1HJ-473	0.047MF 50V MYLAR CAP.			C379	QFV81HJ-154	0.15MF 50V THIN FILM CAP.	
	C262	QETB1VM-228N	2200MF 35V E. CAP.			C380	QFV81HJ-154	0.15MF 50V THIN FILM CAP.	
	C264	QFN82AJ-104	0.1MF 100V MYLAR CAP.			C381	QETB1HM-106	10MF 50V E. CAP.	
	C265	QFN82AJ-104	0.1MF 100V MYLAR CAP.			C382	QETB1HM-106	10MF 50V E. CAP.	
	C266	QETB1HM-225	2.2MF 50V AL E. CAP.			C383	QETB1HM-225	2.2MF 50V AL E. CAP.	
	C267	QFN82AJ-104	0.1MF 100V MYLAR CAP.			C384	QETB1HM-225	2.2MF 50V AL E. CAP.	
	C268	QETB1VM-228N	2200MF 35V E. CAP.			C385	QETB1HM-475E	4.7MF 50V E. CAP.	
	C269	QFLB1HJ-104	0.1MF 50V MYLAR CAP.			C386	QETB1HM-475E	4.7MF 50V E. CAP.	
	C300	QCF21HP-223A	0.022MF 50V CER. CAP.			C387	QETB1HM-475E	4.7MF 50V E. CAP.	
	C301	QETB1HM-475E	4.7MF 50V E. CAP.			C388	QETB1HM-475E	4.7MF 50V E. CAP.	
	C302	QETB1HM-475E	4.7MF 50V E. CAP.			C391	QCHB1EZ-223	0.022MF 25V CER. CAP.	

■ Electric Parts List (Source Select Video Output P. W. B.)

△	Item	Parts Number	Description	Area
	R338	QRD161J-471	470 1/6W CARBON RES.	
	R341	QRD161J-104	100K 1/6W CARBON RES.	
	R342	QRD161J-104	100K 1/6W CARBON RES.	
	R343	QRD161J-104	100K 1/6W CARBON RES.	
		QRD161J-473	47K 1/6W CARBON RES.	
	R344	QRD161J-104	100K 1/6W CARBON RES.	
		QRD161J-473	47K 1/6W CARBON RES.	
	R347	QRD161J-102	1K 1/6W CARBON RES.	
	R348	QRD161J-102	1K 1/6W CARBON RES.	
△	R349	QRZ0077-680	68 1/4W FUSIBLE RES.	
△	R350	QRZ0077-680	68 1/4W FUSIBLE RES.	
	R351	QRD161J-124	120K 1/6W CARBON RES.	
	R352	QRD161J-124	120K 1/6W CARBON RES.	
	R353	QRD161J-432	4.3K 1/6W CARBON RES.	
	R354	QRD161J-432	4.3K 1/6W CARBON RES.	
	R355	QRD161J-103	10K 1/6W CARBON RES.	
	R356	QRD161J-103	10K 1/6W CARBON RES.	
△	R357	QRZ0077-680	68 1/4W FUSIBLE RES.	
△	R358	QRZ0077-680	68 1/4W FUSIBLE RES.	
	R359	QRD161J-104	100K 1/6W CARBON RES.	
	R360	QRD161J-104	100K 1/6W CARBON RES.	
	R361	QRD161J-104	100K 1/6W CARBON RES.	
	R362	QRD161J-104	100K 1/6W CARBON RES.	
	R363	QRD161J-393	39K 1/6W CARBON RES.	
	R364	QRD161J-393	39K 1/6W CARBON RES.	
	R365	QRD161J-224	220K 1/6W CARBON RES.	
	R366	QRD161J-224	220K 1/6W CARBON RES.	
	R367	QRD161J-124	120K 1/6W CARBON RES.	
	R368	QRD161J-124	120K 1/6W CARBON RES.	
	R369	QRD161J-124	120K 1/6W CARBON RES.	
	R370	QRD161J-124	120K 1/6W CARBON RES.	
	R371	QRD161J-103	10K 1/6W CARBON RES.	
	R372	QRD161J-103	10K 1/6W CARBON RES.	
	R373	QRD167J-562	5.6K 1/6W CARBON RES.	
	R375	QRD161J-102	1K 1/6W CARBON RES.	
	R376	QRD167J-562	5.6K 1/6W CARBON RES.	
	R377	QRD161J-102	1K 1/6W CARBON RES.	
	R378	QRD161J-102	1K 1/6W CARBON RES.	
	R380	QRD161J-102	1K 1/6W CARBON RES.	
	R381	QRD161J-124	120K 1/6W CARBON RES.	
	R382	QRD161J-124	120K 1/6W CARBON RES.	
	R385	QRD161J-103	10K 1/6W CARBON RES.	
	R386	QRD161J-103	10K 1/6W CARBON RES.	
	R390	QRD161J-103	10K 1/6W CARBON RES.	
△	R391	QRZ0077-680	68 1/4W FUSIBLE RES.	
△	R392	QRZ0077-680	68 1/4W FUSIBLE RES.	
	R393	QRD167J-511	510 1/6W CARBON RES.	
	R394	QRD167J-511	510 1/6W CARBON RES.	
	R395	QRD161J-203	20K 1/6W CARBON RES.	
		QRD161J-333	33K 1/6W CARBON RES.	
	R396	QRD161J-203	20K 1/6W CARBON RES.	
		QRD161J-333	33K 1/6W CARBON RES.	
	R557	QRD161J-103	10K 1/6W CARBON RES.	
	R558	QRD161J-103	10K 1/6W CARBON RES.	
	R559	QRD167J-113	11K 1/6W CARBON RES.	
	R560	QRD167J-113	11K 1/6W CARBON RES.	
	R561	QRD161J-104	100K 1/6W CARBON RES.	
	R562	QRD161J-104	100K 1/6W CARBON RES.	
	R563	QRD161J-333	33K 1/6W CARBON RES.	
	R564	QRD161J-333	33K 1/6W CARBON RES.	
	R565	QRD161J-124	120K 1/6W CARBON RES.	
	R566	QRD161J-124	120K 1/6W CARBON RES.	
△	R571	QRZ0077-471	470 1/4W FUSIBLE RES.	
△	R572	QRZ0077-471	470 1/4W FUSIBLE RES.	
	R573	QRD161J-681	680 1/6W CARBON RES.	
	R574	QRD167J-272	2.7K 1/6W CARBON RES.	

△	Item	Parts Number	Description	Area
	R641	QRD161J-102	1K 1/6W CARBON RES.	
	R642	QRD161J-102	1K 1/6W CARBON RES.	
	R643	QRD161J-163	16K 1/6W CARBON RES.	
	R644	QRD161J-393	39K 1/6W CARBON RES.	
	R651	QRD161J-105	1M 1/6W CARBON RES.	
	R662	QRD161J-102	1K 1/6W CARBON RES.	
	R663	QRD161J-102	1K 1/6W CARBON RES.	
	R666	QRD161J-474	470K 1/6W CARBON RES.	
△	R881	QRX012J-R22A	0.22 1W METAL FILM R	
△		QRX012J-1R2A	1.2 1W METAL FILM R	
△	R882	QRX012J-R22A	0.22 1W METAL FILM R	
△		QRX012J-1R2A	1.2 1W METAL FILM R	
	RA551	QRB039J-474	470K 1/10W CARBON RES.	
	RA552	QRB039J-474	470K 1/10W CARBON RES.	
		OTHERS		
		EMW10703-002	PRINTED BOARD	
		EMW10703-004	CIR. BOARD	
		QWE350-16RR	VINYL WIRE	
		SBSG3008CC	TAPPING SCREW	
	J221	EMN00TV-116A	PIN JACK	
	J222	EMN01TV-102A	PIN JACK	
	J223	EMN00TV-217A	PIN JACK	
	J301	EMN00TV-422AJ2	PIN JACK	
	J302	EMN00TV-622AJ2	PIN JACK	
	J303	EMN00TV-622AJ2	PIN JACK	
	X641	ECXP8R0-001Z	CRYSTAL	
	CN312	EMV5109-003B	CONNECT TERMINAL	
	CN413	EMV5109-009A	PIN PLUG	
	CN415	VMC0163-013	CONNECT TERMINAL	
	CN511	EMV5163-011R	CONNECT TERMINAL	
	CN603	EMV7163-009	CONNECT TERMINAL	
	CN611	EMV5163-007R	CONNECT TERMINAL	
	CN612	EMV5163-011R	CONNECT TERMINAL	
	CN613	EMV5163-009R	CONNECT TERMINAL	
	CN802	EWS273-005	SOCKET WIRE ASSY	
	CN803	VMC0177-003	CONNECT TERMINAL	
	CN805	EMV7163-007	CONNECT TERMINAL	
	CN811	EMV5163-007R	CONNECT TERMINAL	
	CN815	EMV5163-007R	CONNECT TERMINAL	
	EP250	EMZ4002-002Z	EARTH PLATE	
	FC881	EMG7331-003Z	FUSE CLIP	
	FC882	EMG7331-003Z	FUSE CLIP	
	FC883	EMG7331-003Z	FUSE CLIP	
	FC884	EMG7331-003Z	FUSE CLIP	
	FW211	EWR37D-16LS	FLAT WIRE	
	HS881	E408032-002SS	HEAT SINK	
	LA851	E67132-T2R0	FUSE LABEL	
	LA852	E67132-T2R0	FUSE LABEL	

■ Accessories List

Block No. **M2MM**

△	Item	Parts Number	Parts Name	Q'ty	Description	Area
	1	LET0055-001A	INSTRUCTION BOOK	1		EFG
	1	LET0055-002A	INSTRUCTION BOOK	1		EN
	1	LET0055-003A	INSTRUCTION BOOK	1		BS
	2	E309758-001	POLY BAG	1		
	3	RM-SR630RUKP	REMOCON	1		
	4	BT-54008-1	WARRANTY CARD	1		
	5	EWP503-001	ANTENNA WIRE	1		
	6	EQB4001-015	LOOP ANTENNA	1		
	7	R6PPTT-2STSM	BATTERY	2		
	8	E43486-340A	SAFETY SHEET	1		BS

Packing Materials and Parts Numbers

Block No. **M3M**

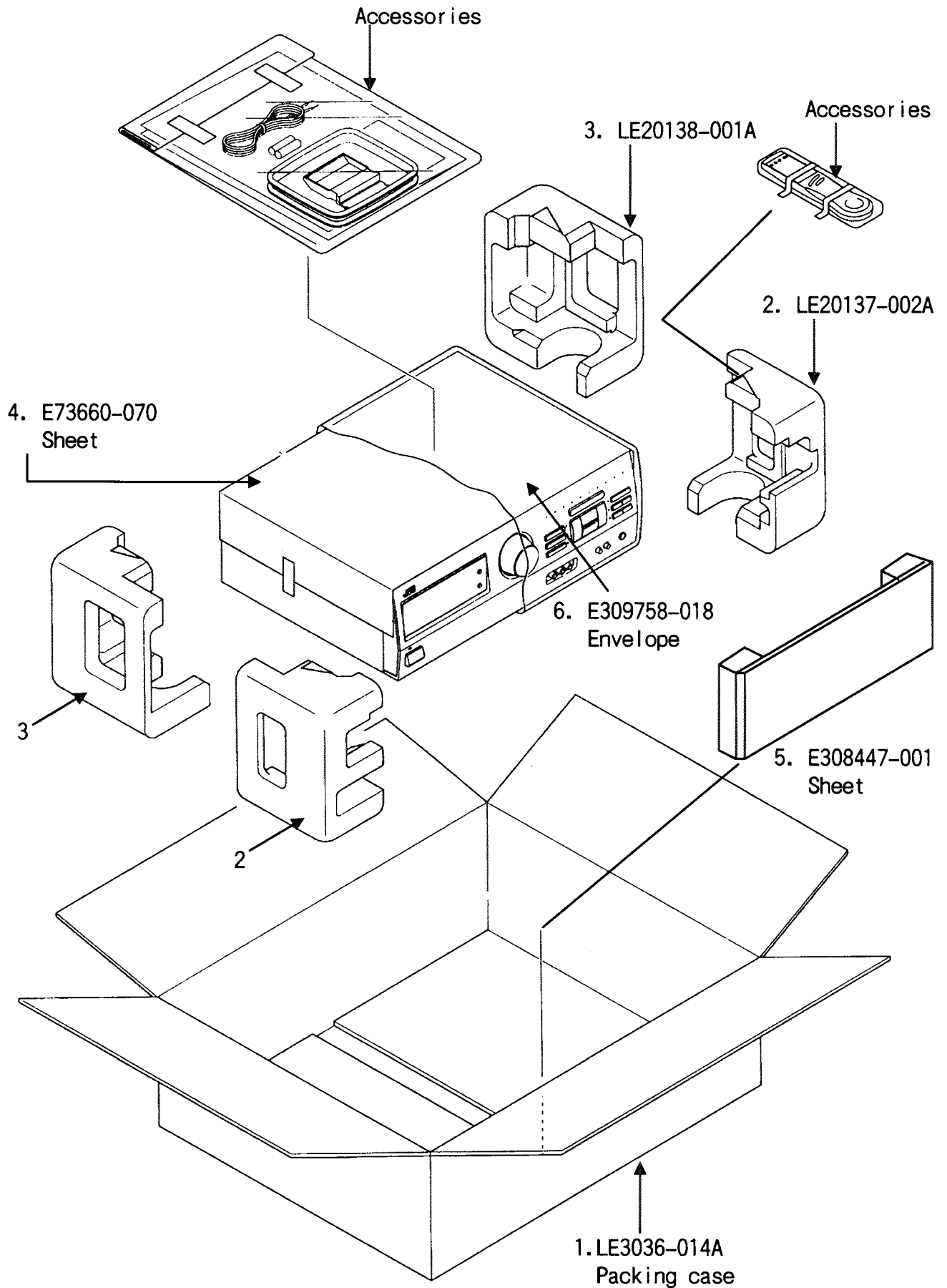

RX-630RBK

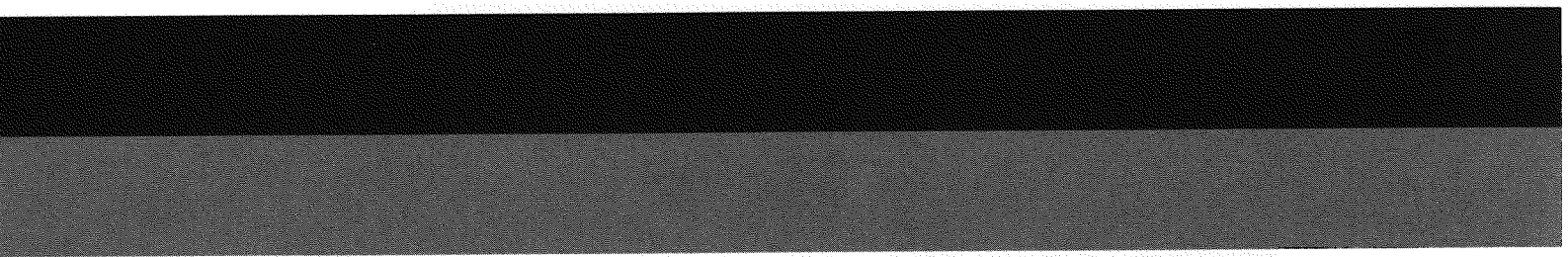

JVC

VICTOR COMPANY OF JAPAN, LIMITED

AUDIO DIVISION, 10-1, Chome, Ohwatari-machi, maebashi-city, Japan

(No.20641)

 Printed in Japan
9710(V)